

Part No. 060303-10, Rev. F
September 2015

OmniSwitch 6250

Hardware Users Guide

Alcatel·Lucent 
Enterprise

enterprise.alcatel-lucent.com

This user guide documents the OmniSwitch 6250 for AOS Release 6.7.1.

This user guide documents OmniSwitch 6250 hardware, including chassis and associated components. The specifications described in this guide are subject to change without notice.

enterprise.alcatel-lucent.com Alcatel-Lucent and the Alcatel-Lucent Enterprise logo are trademarks of Alcatel-Lucent. To view other trademarks used by affiliated companies of ALE Holding, visit: enterprise.alcatel-lucent.com/trademarks. All other trademarks are the property of their respective owners. The information presented is subject to change without notice. Neither ALE Holding nor any of its affiliates assumes any responsibility for inaccuracies contained herein. (July 2015)



26801 West Agoura Road
Calabasas, CA 91301
(818) 880-3500 FAX (818) 880-3505

Service & Support Contact Information

North America: 800-995-2696

Latin America: 877-919-9526

EMEA: +800 00200100 (Toll Free) or +1(650)385-2193

Asia Pacific: +65 6240 8484

Web: service.esd.alcatel-lucent.com

Email: esd.support@alcatel-lucent.com

Contents

	About This Guide	ix
	Supported Platforms	ix
	Who Should Read this Manual?	xi
	When Should I Read this Manual?	xi
	What is in this Manual?	xi
	What is Not in this Manual?	xi
	How is the Information Organized?	xii
	Documentation Roadmap	xii
	Related Documentation	xiv
	Product Documentation	xv
	Technical Support	xv
	Documentation Feedback	xv
Chapter 1	OmniSwitch 6250	1-1
	Chassis Configurations	1-2
	OmniSwitch 6250 Feature Overview	1-3
	Security Features	1-3
	Applications	1-3
	Availability Features	1-4
	Software Rollback	1-4
	Hot Swapping	1-4
	Hardware Monitoring	1-5
	Backup Power Supplies	1-5
Chapter 2	Getting Started	1-1
	Installing the Hardware	1-1
	Items Required	1-1
	Site Preparation	1-1
	Environmental Requirements	1-1
	Electrical Requirements	1-1
	Unpacking and Installing the Switch	1-2
	Items Included	1-2
	Weight Considerations	1-2
	Airflow Considerations	1-3
	Mounting the Switch	1-3

Connections and Cabling	1-4
Serial Connection to the Console Port	1-4
Serial Connection Default Settings	1-4
Booting the Switch	1-5
Component LEDs	1-5
Your First Login Session	1-6
Logging In to the Switch	1-6
Unlocking Session Types	1-7
Changing the Login Password	1-8
Setting the System Time Zone	1-8
Setting the Date and Time	1-8
Setting Optional Parameters	1-9
Specifying an Administrative Contact	1-9
Specifying a System Name	1-9
Specifying the Switch's Location	1-9
Viewing Your Changes	1-9
Saving Your Changes	1-9
Chapter 3	
OmniSwitch 6250 Chassis and Hardware Components	3-1
OmniSwitch 6250-8M	3-3
OmniSwitch 6250-8M Rear Panel	3-5
OmniSwitch 6250-24M/24MD	3-7
OmniSwitch 6250-24M/24-MD Rear Panel	3-9
OmniSwitch 6250-24	3-12
OmniSwitch 6250-24 Rear Panel	3-14
OmniSwitch 6250-P24	3-16
OmniSwitch 6250-P24 Rear Panel	3-18
LED Status	3-20
OS6250 - Power Supplies	3-21
Internal AC Power Supply	3-22
Internal DC Power Supply	3-23
PS-42W-AC Power Brick	3-24
PS-30W-DC Power Brick	3-25
PS-225W-AC-P PoE Power Supply Module	3-26
Power Supply Tray	3-27
AC Power Cords	3-28
Specifications	3-28
DC Power Specifications	3-29
OS6250-24MD Internal DC Power Supply	3-29
Backup DC Power Brick	3-29
Stacking Cables	3-30
Console Port	3-31

Port Pinouts	3-32
RJ-45 Console Port – Connector Pinout	3-32
10/100 Ethernet Port – RJ-45 Pinout (non-PoE)	3-32
Gigabit Ethernet Port – RJ-45 Pinout	3-32
10/100/1000 Mbps Power over Ethernet Port – RJ-45 Pinout	3-33
Overtemp Condition	3-33
Dying Gasp	3-34
Scenarios	3-34
SNMP Trap	3-34
Syslog Message	3-34
Link OAM PDU	3-35
Chapter 4	
Mounting OS6250 Switches	4-1
Chassis Components	4-1
Available Mounting Kits	4-2
General Installation Recommendations	4-3
Cooling Recommendations	4-3
Recommended Clearances	4-4
Mechanical Loading	4-4
Circuit Overloading	4-4
Reliable Earthing	4-4
Power Supply Information	4-5
Assembling OS6250 Switches	4-6
Assembly Guidelines	4-6
Attaching the Power Supply Tray on Side of Chassis	4-6
OS6250-RM-19 - Power supply tray side installation	4-6
OS6250-DUAL-MNT - Attaching Two Chassis Side-by-Side	4-10
Attaching Power Supply Tray to Rear of Chassis	4-12
Securing Power Supplies in Power Supply Tray	4-13
Power Supply Brick Installation	4-13
Power Supply Module Installation	4-14
Mounting OS6250 Switches	4-15
Rack-Mounting OS6250 Switches	4-15
General Rack-Mounting Guidelines	4-15
Rack-Mounting Installation	4-15
Power Supply Tray - Removeable Section	4-17
OS6250-RM-19-L - Mounting Instructions	4-18
OS6250-REAR-MNT - Mounting Instructions	4-19
Steps	4-19
Completed Assembly	4-20
Table-Mounting OS6250 Switches	4-21
General Table-Mounting Guidelines	4-21
Table-Mounting Installation	4-21
Wall-Mounting the OS6250-8M	4-23
General Wall-Mounting Guidelines	4-23
OS6250-WALL-MNT - Wall-Mounting Installation	4-24

	Connecting Chassis to Power Source	4-26
	AC Power Supply Connections	4-26
	Powering On a Chassis	4-26
	OS6250-24MD Internal DC Power Supply Connections	4-27
	Backup DC Power Brick Connections	4-27
	Securing the Redundant DC Power Supply Connector	4-28
	Installing DC Power Source Wire Leads	4-29
	Hot-Swapping Power Supplies	4-31
Chapter 5	Booting 6250 Switches	5-1
	Booting an OmniSwitch 6250	5-1
	Console Port	5-2
	Serial Connection Default Settings	5-2
	Modifying the Serial Connection Settings	5-2
	Viewing the Power Supply Status	5-4
	Monitoring the Chassis	5-5
	Checking the Overall Chassis Status	5-5
	Checking the Temperature Status	5-5
	Checking the Fan Status	5-6
	Checking the Power Supply Status	5-6
	Additional Monitoring Commands	5-6
	Using LEDs to Visually Monitor the Chassis	5-7
	Installing SFP and XFP Transceivers	5-7
Chapter 6	Managing Power over Ethernet (PoE)	6-1
	In This Chapter	6-2
	Power over Ethernet Specifications	6-3
	Viewing PoE Power Supply Status	6-4
	Configuring Power over Ethernet Parameters	6-5
	Power over Ethernet Defaults	6-5
	Understanding and Modifying the Default Settings	6-5
	Setting the PoE Operational Status	6-5
	Configuring the Total Power Available to a Port	6-6
	Configuring the Total Power Available to a Switch	6-6
	Setting Port Priority Levels	6-7
	Understanding Priority Disconnect	6-8
	Setting Priority Disconnect Status	6-8
	Disabling Priority Disconnect	6-8
	Enabling Priority Disconnect	6-8
	Monitoring Power over Ethernet via CLI	6-11

Chapter 7	Managing OmniSwitch 6250 Stacks	7-1
	In This Chapter	7-2
	OmniSwitch 6250 Stacking Specifications	7-3
	Changing Stacking Mode on Metro Models	7-3
	OmniSwitch 6250 Stack Overview	7-4
	Roles Within the Stack	7-4
	Primary and Secondary Management Modules	7-4
	Primary Management Module Selection	7-7
	Secondary Management Module Selection	7-10
	Idle Module Role	7-12
	Pass-Through Mode	7-13
	Recovering from Pass-Through Mode (Duplicate Slot Numbers)	7-14
	Stack Cabling	7-17
	Redundant Stacking Cable Connection	7-18
	Checking Redundant Stacking Cable Status	7-19
	Slot Numbering	7-20
	Dynamic Slot Number Assignment	7-21
	Manual Slot Number Assignment	7-23
	Reverting to the Dynamic Slot Numbering Model	7-24
	Hot-Swapping Modules In a Stack	7-25
	Removing Switches from an Existing Stack	7-25
	Inserting Switches Into an Existing Stack	7-25
	Merging Stacks	7-26
	Reloading Switches	7-27
	Reloading the Primary Management Module	7-27
	Reloading the Secondary Management Module	7-29
	Reloading Switches with Idle Roles	7-31
	Reloading Switches in Pass-Through Mode	7-31
	Reloading All Switches in a Stack	7-32
	Software Synchronization During a Full Reload	7-32
	Effects of Saved Slot Number Information on the Reload Process	7-32
	Avoiding Split Stacks	7-34
	Changing the Secondary Module to Primary	7-35
	Synchronizing Switches in a Stack	7-37
	Automatic Synchronization During a Full Reload	7-37
	Stack Split Detection (SSP)	7-38
	Stack Split Key Components and Terms	7-38
	Basic Operation	7-39
	Protection States	7-39
	Stack Split Recovery	7-39
	Monitoring the Stack	7-41
	Visually Monitoring the Stack	7-42

Appendix A	Regulatory Compliance and Safety Information	A-1
	Declaration of Conformity: CE Mark	A-1
	China RoHS: Hazardous Substance Table	A-2
	California Proposition 65 Warning	A-3
	Waste Electrical and Electronic Equipment (WEEE) Statement	A-4
	Standards Compliance	A-5
	Safety Agency Certifications	A-5
	EMI/EMC Standards	A-5
	FCC Class A, Part 15	A-6
	Canada Class A Statement	A-6
	JATE	A-6
	CISPR22 Class A warning	A-6
	Korean Emission Statement	A-7
	VCCI	A-7
	Class A Warning for Taiwan and Other Chinese Markets	A-7
	Network Cable Installation Warning	A-8
	Translated Safety Warnings	A-8
	Chassis Lifting Warning	A-8
	Electrical Storm Warning	A-8
	Installation Warning	A-9
	Invisible Laser Radiation Warning	A-9
	Power Disconnection Warning	A-9
	Proper Earthing Requirement Warning	A-10
	Read Important Safety Information Warning	A-11
	Restricted Access Location Warning	A-11
	Wrist Strap Warning	A-12
	Instrucciones de seguridad en español	A-13
	Advertencia sobre el levantamiento del chasis	A-13
	Advertencia de las tapaderas en blanco	A-13
	Advertencia en caso de tormenta eléctrica	A-13
	Advertencia de instalación	A-13
	Advertencia de radiación láser invisible	A-13
	Advertencia de la batería de litio	A-13
	Advertencia sobre la tensión de operación	A-13
	Advertencia sobre la desconexión de la fuente	A-13
	Advertencia sobre una apropiada conexión a tierra	A-14
	Leer “información importante de seguridad”	A-14
	Advertencia de acceso restringido	A-14
	Advertencia de pulsera antiestática	A-14
	Clase de seguridad	A-14

About This Guide

This *OmniSwitch 6250 Hardware Users Guide* describes your switch hardware components and basic switch hardware procedures.

Supported Platforms

The information in this guide applies to the following products:

- OmniSwitch 6250-8M
- OmniSwitch 6250-24M
- OmniSwitch 6250-24MD
- OmniSwitch 6250-24
- OmniSwitch 6250-P24

Unsupported Platforms

The information in this guide does not apply to the following products:

- OmniSwitch (original version with no numeric model name)
- OmniSwitch 6400 Series
- OmniSwitch 6600 Series
- OmniSwitch 6800 Series
- OmniSwitch 6850 Series
- OmniSwitch 6855 Series
- OmniSwitch 7700
- OmniSwitch 7800
- OmniSwitch 8800
- OmniSwitch 9000 Series
- OmniStack
- OmniAccess

Who Should Read this Manual?

The audience for this users guide is network administrators and IT support personnel who need to configure, maintain, and monitor switches and routers in a live network. However, anyone wishing to gain knowledge on the OmniSwitch 6250 hardware will benefit from the material in this guide.

When Should I Read this Manual?

Read this guide as soon as you are ready to familiarize yourself with your switch hardware components. You should have already stepped through the first login procedures and read the brief hardware overviews in the *OmniSwitch 6250 Getting Started Guide*.

You should already be familiar with the very basics of the switch hardware, such as module LEDs and module installation procedures. This manual will help you understand your switch hardware components (e.g., chassis, stacking and cables, backup power supplies, etc.) in greater depth.

What is in this Manual?

This users guide includes the following hardware-related information:

- Descriptions of switch configurations.
- Descriptions of “availability” features.
- Descriptions of chassis types (e.g., the OS6250-24).
- Instructions for mounting the chassis.
- Descriptions of hardware components (status LEDs, chassis, cables, backup power supplies, etc.).
- Managing a chassis.
- Hardware-related Command Line Interface (CLI) commands

What is Not in this Manual?

The descriptive and procedural information in this manual focuses on switch hardware. It includes information on some CLI commands that pertain directly to hardware configuration, but it is not intended as a software users guide. There are several OmniSwitch 6250 users guides that focus on switch software configuration. Consult those guides for detailed information and examples for configuring your switch software to operate in a live network environment. See [“Documentation Roadmap” on page -xii](#) and [“Related Documentation” on page -xiv](#) for further information on software configuration guides available for your switch.

How is the Information Organized?

This users guide provides an overview of OmniSwitch 6250 switches, specifications of the hardware components, steps for setting up and managing OmniSwitch 6250 switches, and an overview and procedures for managing Power over Ethernet (PoE).

Documentation Roadmap

The OmniSwitch user documentation suite was designed to supply you with information at several critical junctures of the configuration process. The following section outlines a roadmap of the manuals that will help you at each stage of the configuration process. Under each stage, we point you to the manual or manuals that will be most helpful to you.

Stage 1: Using the Switch for the First Time

Pertinent Documentation: *Getting Started Guide*
Release Notes

The *Getting Started Guide* provides all the information you need to get your switch up and running the first time. This guide provides information on unpacking the switch, installing power supplies, unlocking access control, setting the switch's IP address, and setting up a password. It also includes succinct overview information on fundamental aspects of the switch, such as hardware LEDs, the software directory structure, stacking, CLI conventions, and web-based management.

At this time you should also familiarize yourself with the Release Notes that accompanied your switch. This document includes important information on feature limitations that are not included in other user guides.

Stage 2: Gaining Familiarity with Basic Switch Functions

Pertinent Documentation: *Hardware Users Guide*
Switch Management Guide

Once you have your switch up and running, you will want to begin investigating basic aspects of its hardware and software. Information about switch hardware is provided in the *Hardware Users Guide*. This guide provide specifications, illustrations, and descriptions of all hardware components—e.g., chassis, backup power supplies, etc.

The *Switch Management Guide* is the primary user guide for the basic software features on a switch. This guide contains information on the switch directory structure, basic file and directory utilities, switch access security, SNMP, and web-based management. It is recommended that you read this guide before connecting your switch to the network.

Stage 3: Integrating the Switch Into a Network

Pertinent Documentation: *Network Configuration Guide*

When you are ready to connect your switch to the network, you will need to learn how the OmniSwitch implements fundamental software features, such as 802.1Q, VLANs, and Spanning Tree. The *Network Configuration Guide* contains overview information, procedures and examples on how standard networking technologies are configured in the OmniSwitch 6250.

Anytime

The *OmniSwitch CLI Reference Guide* contains comprehensive information on all CLI commands supported by the switch. This guide includes syntax, default, usage, example, related CLI command, and CLI-to-MIB variable mapping information for all CLI commands supported by the switch. This guide can be consulted anytime during the configuration process to find detailed and specific information on each CLI command.

Related Documentation

The following are the titles and descriptions of all the OmniSwitch 6250 user manuals:

- *OmniSwitch 6250 Getting Started Guide*

Describes the hardware and software procedures for getting an OmniSwitch 6250 switch up and running. Also provides information on fundamental aspects of OmniSwitch software.

- *OmniSwitch 6250 Hardware Users Guide*

Detailed technical specifications and procedures for the OmniSwitch 6250 chassis and components. This manual also includes comprehensive information on assembling and managing stacked configurations.

- *OmniSwitch 6250/6450 CLI Reference Guide*

Complete reference to all CLI commands supported on the OmniSwitch Series of products. Includes syntax definitions, default values, examples, usage guidelines and CLI-to-MIB variable mappings.

- *OmniSwitch 6250/6450 Switch Management Guide*

Includes procedures for readying an individual switch for integration into a network. Topics include the software directory architecture, image rollback protections, authenticated switch access, managing switch files, system configuration, using SNMP, and using web management software (WebView).

- *OmniSwitch 6250/6450 Network Configuration Guide*

Includes network configuration procedures and descriptive information on all the major software features and protocols included in the base software package. Chapters cover Layer 2 information (Ethernet and VLAN configuration), Layer 3 information (routing protocols, such as RIP), security options (authenticated VLANs), Quality of Service (QoS), and link aggregation.

- *OmniSwitch 6250/6450 Transceivers Guide*

Includes SFP and XFP transceiver specifications and product compatibility information.

- *Technical Tips, Field Notices*

Includes information published by Alcatel-Lucent's Customer Support group.

- *Release Notes and Upgrade Instructions*

Includes open problem reports, feature exceptions, and other important information on the features supported in the current release and any limitations to their support.

Product Documentation

All products are shipped with a Product Documentation Card that provides details for downloading documentation for all OmniSwitch and other Alcatel-Lucent data enterprise products. All user guides for the OmniSwitch Series are included on the Alcatel-Lucent public website. This website also includes user guides for other Alcatel-Lucent Enterprise products. The latest user guides can be found on our website at:

<http://enterprise.alcatel-lucent.com/UserGuides>

Technical Support

An Alcatel-Lucent service agreement brings your company the assurance of 7x24 no-excuses technical support. You'll also receive regular software updates to maintain and maximize your Alcatel-Lucent product's features and functionality and on-site hardware replacement through our global network of highly qualified service delivery partners. Additionally, with 24-hour-a-day access to Alcatel-Lucent's Service and Support web page, you'll be able to view and update any case (open or closed) that you have reported to Alcatel-Lucent's technical support, open a new case or access helpful release notes, technical bulletins, and manuals. For more information on Alcatel-Lucent's Service Programs, see our web page at service.esd.alcatel-lucent.com, call us at 1-800-995-2696, or email us at esd.support@alcatel-lucent.com.

Documentation Feedback

Alcatel-Lucent values comments on the quality and usefulness of the documentation. To send comments on the OmniSwitch documentation use the following email address: feedback.osdocs@alcatel-lucent.com.

For document identification it's helpful to include the Document Title, Part Number and Revision (which can be found on the title page) with any comments.

1 OmniSwitch 6250

The Alcatel-Lucent OmniSwitch 6250 is a set of stackable switches designed for Enterprise and Metro applications providing Fast Ethernet connectivity with Advanced Layer 2 software and basic routing.

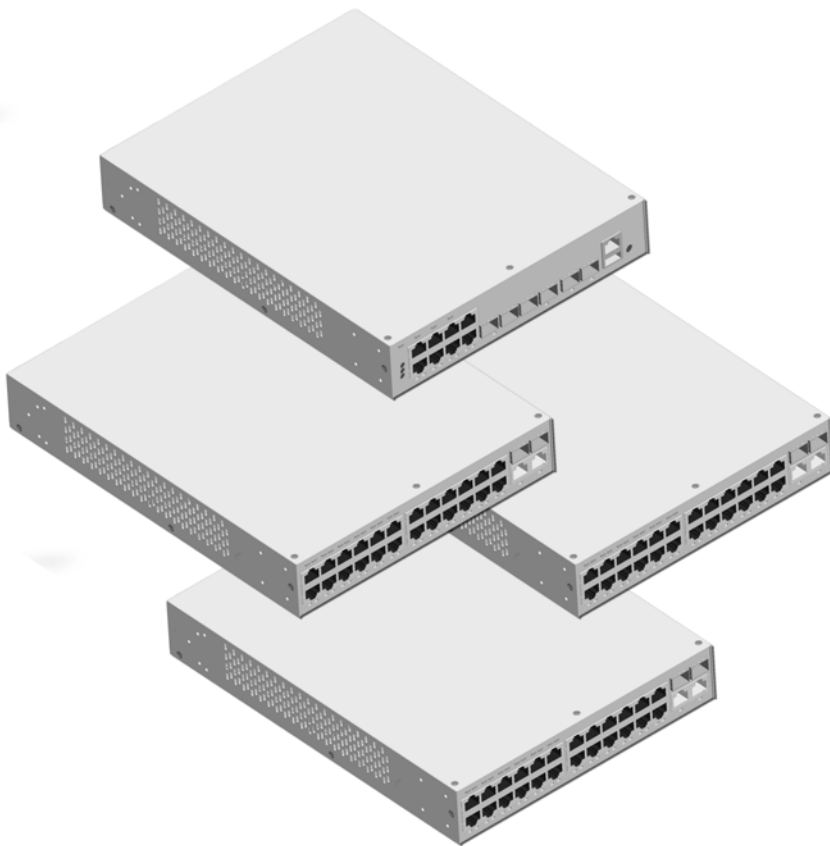

OS6250-8M

OS6250-24M

OS6250-24MD

OS6250-24

OS6250-P24

OS6250 Switches

Chassis Configurations

OmniSwitch 6250 (OS6250) switches offer port densities of up to 24 Fast Ethernet ports. The following OS6250 chassis configurations are available:

Metro Models

- OS6250-8M: Provides eight (8) Fast Ethernet ports, two (2) combo ports, two (2) non-combo fiber ports, and an internal AC power supply.
- OS6250-24M: Provides twenty-four (24) Fast Ethernet ports, two (2) combo ports, two (2) non-combo fiber ports, an internal AC power supply, and optional redundant external power supply.
- OS6250-24MD: Provides twenty-four (24) Fast Ethernet ports, two (2) combo ports, two (2) non-combo fiber ports, an internal DC power supply, and optional redundant external power supply.

Enterprise Models

- OS6250-24: Provides twenty-four (24) Fast Ethernet ports, two (2) combo ports, two HDMI stacking ports, an internal AC power supply, and optional external redundant power supply.
- OS6250-P24: Provides twenty-four (24) PoE Fast Ethernet ports, two (2) combo ports, two (2) HDMI stacking ports, and external primary and redundant power supplies.

Combo Ports

Combo ports are individually configurable to be 10/100/1000BaseT or 100/1000X that can support SFP transceivers for short, long and very long distances.

Non-combo Fiber Ports

The non-combo fiber ports provide uplink or stacking capability through the use of the SFP+ ports.

HDMI Ports

The HDMI ports provide stacking capability through the use of Alcatel-Lucent proprietary stacking cables.

OmniSwitch 6250 Feature Overview

Security Features

OmniSwitch 6250 switches offer extensive security features for network access control, policy enforcement and attack containment, enabling fully secure networks and OmniVista Network Management System (NMS) support.

Applications

Well-suited for traditional enterprise network applications as well as Metro deployments.

- Small and Medium sized Enterprise (SME)
- Metro Ethernet Access
- Residence and business deployments
- Carrier Ethernet (e.g., Telco, CityNets, Metro access)

Availability Features

OmniSwitch 6250 switches incorporate advanced Alcatel-Lucent Operating System (AOS) protocols to ensure high availability for mission critical applications. Availability features are hardware- and software-based safeguards that help to prevent the loss of data flow in the unlikely event of a subsystem failure.

In addition, some availability features allow users to maintain or replace hardware components without powering off the switch or interrupting switch operations. Combined, these features provide added resiliency and help to ensure that the switch or virtual chassis is consistently available for high-impact network operations.

Hardware-related availability features include:

- [Software Rollback](#)
- [Hot Swapping](#)
- [Hardware Monitoring](#)
- [Backup Power Supplies](#)

Software Rollback

Software rollback (also referred to as *image rollback*) essentially allows the switch to return to a prior “last known good” version of software in the event of a system software problem. The switch controls software rollback through its resilient directory structure design (i.e., `/flash/working` and `/flash/certified`).

For detailed information on the software rollback feature, as well as the switch’s `/flash/working` and `/flash/certified` directories, refer to the “Managing CMM Directory Content” chapter in the *Switch Management Guide*.

Hot Swapping

Hot swapping refers to the action of adding, removing, or replacing components without powering off switches or disrupting other components. This feature facilitates hardware upgrades and maintenance and allows users to easily replace components in the unlikely event of hardware failure.

The following components can be hot swapped:

- Backup power supplies
- Power supply connector cables
- SFPs

Note. For instructions on hot swapping backup power supplies, refer to [Chapter 4, “Mounting OS6250 Switches”](#) For instructions on hot swapping combo connector SFPs, refer to the instruction card provided with the SFP.

Hardware Monitoring

Automatic Monitoring

Automatic monitoring refers to the switch's built-in sensors that automatically monitor operations. If an error is detected (e.g., over-threshold temperature), the switch immediately sends a trap to the user. The trap is displayed on the console in the form of a text error message.

LEDs

LEDs, which provide visual status information, are provided on the chassis front panel. LEDs are used to indicate conditions such as hardware and software status, temperature errors, link integrity, data flow, etc. For detailed LED descriptions, refer to [Chapter 3, “OmniSwitch 6250 Chassis and Hardware Components.”](#)

User-Driven Monitoring

User-driven hardware monitoring refers to CLI commands that are entered by the user in order to access the current status of hardware components. The user enters “show” commands that output information to the console. Monitoring information for chassis components, such as the optional back up power supply, chassis temperature sensor, and chassis fans is provided in [Chapter 3, “OmniSwitch 6250 Chassis and Hardware Components.”](#) The show commands for all the features are described in detail in the *OmniSwitch CLI Reference Guide*.

Backup Power Supplies

Some OmniSwitch 6250 switches support an optional backup power supply. Backup power supplies operate in active standby mode. If the primary power supply fails unexpectedly, the backup power supply automatically takes up the full power load without disrupting the switch.

Note. For more information on power supplies, refer to [Chapter 3, “OmniSwitch 6250 Chassis and Hardware Components.”](#)

2 Getting Started

Installing the Hardware

Items Required

- Grounding wrist strap
- Phillips screwdriver
- Flat-blade screwdriver

Site Preparation

Environmental Requirements

OmniSwitch 6250 switches have the following environmental and airflow requirements:

- The installation site must maintain a temperature between 0° and 45° Celsius (32° and 113° Fahrenheit) and not exceed 95 percent maximum humidity (non-condensing) at any time.
- Be sure to allow adequate room for proper air ventilation at the front, back, and sides of the switch. Refer to [“Airflow Considerations” on page 2-3](#) for minimum clearance requirements. No clearance is necessary at the top or bottom of the chassis.

Electrical Requirements

Note. Alcatel-Lucent switches must be installed by a professional installer. It is the responsibility of the installer to ensure that proper grounding is available and that the installation meets applicable local and national electrical codes.

OmniSwitch 6250 switches have the following general electrical requirements:

- Each switch requires one grounded electrical outlet for the chassis power supply. OmniSwitch 6250 switches offer AC power supply support only. Refer to the following chapters for more information.
- Each supplied AC power cord is 2 meters (approx. 6.5 feet). Do not use extension cords.

Redundant AC Power. It is recommended that each AC outlet resides on a separate circuit. With redundant AC, if a single circuit fails, the switch’s remaining power supplies (on separate circuits) can remain operational.

Unpacking and Installing the Switch

To protect your switch components from damage, read all unpacking recommendations and instructions carefully before beginning.

Unpack your OmniSwitch 6250 chassis as close as possible to the location where it will be installed.

Items Included

Your OmniSwitch 6250 includes the following items:

- OmniSwitch chassis
- Transceivers, per order
- Rack mount brackets
- Country-specific power cord(s)
- Assorted instructional cards, anti-static bags and additional packaging

Weight Considerations

The OmniSwitch 6250 chassis weighs approximately 1.72 kg (3.80 lb).

Airflow Considerations

To ensure proper airflow, be sure that your switch is placed in a well-ventilated area and provide minimum recommended clearance at the front, back and sides of the switch.

Never obstruct chassis air vents.

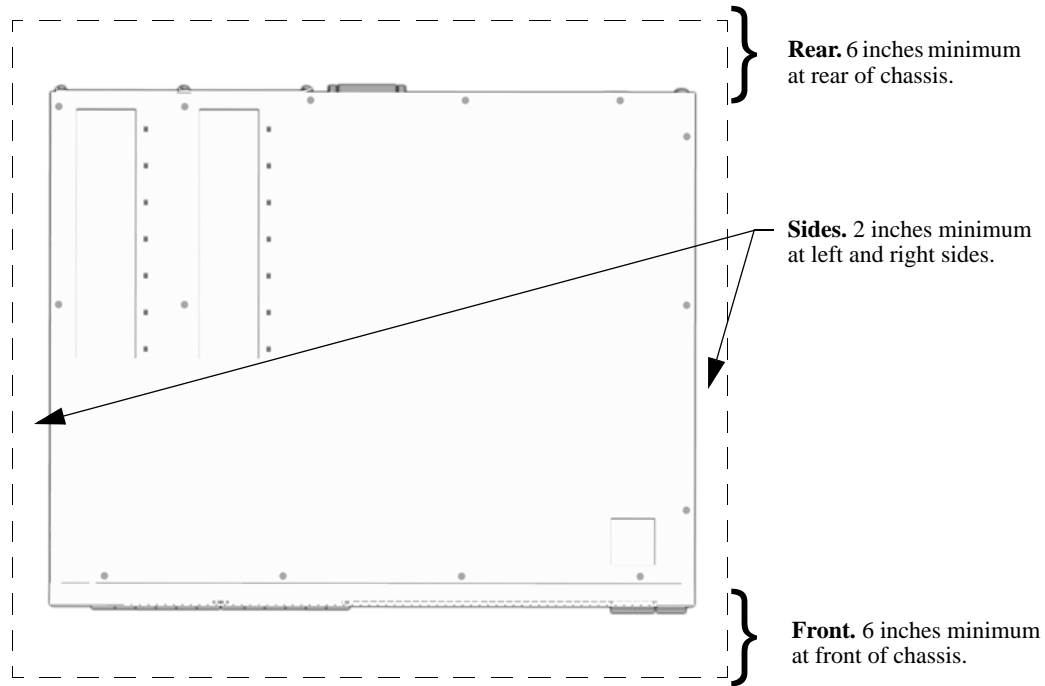

Chassis Top View

Note. Clearance is not required at the top and bottom of the chassis.

Mounting the Switch

For information on mounting OmniSwitch 6250 switches, refer to [Chapter 3, “OmniSwitch 6250 Chassis and Hardware Components.”](#)

Connections and Cabling

Once your switch is properly installed, you should connect all network and management cables required for your network applications. Connections may include:

- DB9-to-RJ-45 cable to the console connector
- Cables to 10/100/1000 Ethernet or SFP ports

Note. For additional information on cabling connections, refer to the *OmniSwitch AOS Release 6 Switch Management Guide*.

Serial Connection to the Console Port

The console port provides a serial connection to the switch using a USB connector and is required when logging into the switch for the first time. By default, this connector provides a DCE console connection.

Serial Connection Default Settings

baud rate	9600
parity	none
data bits (word size)	8
stop bits	1

For information on modifying these settings, refer to the *OmniSwitch AOS Release 6 Switch Management Guide*.

Booting the Switch

Now that you have installed the switch components and connected network and management cables, you can boot the switch. To boot the switch, plug the power supply cord into an easily-accessible, properly grounded power outlet. (Do not use extension cords.) The switch will power on and boot automatically.

Component LEDs

During the boot process, component LEDs will flash and change color, indicating different stages of the boot. Following a successful boot, chassis LEDs should display as follows:

OK1	Solid Green
PRI	Solid Green
PWR	Solid Green

Note. If the LEDs do not display as indicated, make sure the boot process is complete. If the LEDs do not display as indicated following a complete boot sequence, contact Alcatel-Lucent Customer Support. For information on LED states, refer to [“Chassis Status LEDs” on page 3-19](#).

Once the switch has completely booted and you have accessed your computer’s terminal emulation software via the console port, you are ready to log in to the switch’s Command Line Interface (CLI) and configure basic information. Continue to [“Your First Login Session” on page 2-6](#).

Your First Login Session

In order to complete the setup process for the switch, you must complete the following steps during your first login session:

- Log in to the switch
- Unlock session types
- Change the login password
- Set the date and time
- Set optional system information
- Save your changes

Important. You must be connected to the switch via the console port before initiating your first login session.

Logging In to the Switch

When you first log in to the switch, you will be prompted for a login name and password. Use the switch's default settings:

- Login: **admin**
- Password: **switch**

The default welcome banner, which includes information such as the current software version and system date, is displayed followed by the CLI command prompt:

```
Welcome to the Alcatel-Lucent OmniSwitch 6250
Software Version 6.7.1.80.R01 Development, July 08, 2015.

Copyright(c), ALE USA Inc., 2015. All Rights reserved.

OmniSwitch(TM) is a trademark of Alcatel-Lucent Enterprise registered
in the United States Patent and Trademark Office.

->
```

Note. A user account includes a login name, password, and user privileges. Privileges determine whether the user has read or write access to the switch and which commands the user is authorized to execute. For detailed information on setting up and modifying user accounts, refer to the *OmniSwitch AOS Release 6 Switch Management Guide*.

Unlocking Session Types

Security is a key feature on OmniSwitch 6250 switches. As described on [page 2-6](#), when you access the switch for the first time, you must use a *direct console port connection*. All other session types (Telnet, FTP, WebView, and SNMP) are locked out until they are manually unlocked by the user.

The CLI command used to unlock session types is **aaa authentication**.

Note. When you unlock session types, you are granting switch access to non-local sessions (e.g., Telnet). As a result, users who know the correct user login and password will have remote access to the switch. For more information on switch security, refer to the *OmniSwitch AOS Release 6 Switch Management Guide*.

Unlocking All Session Types

To unlock all session types, enter the following command syntax at the CLI prompt:

```
-> aaa authentication default local
```

Unlocking Specified Session Types

You can also unlock session types on a one-by-one basis. For example, to unlock Telnet sessions only, enter the following command:

```
-> aaa authentication telnet local
```

To unlock WebView (HTTP) sessions only, enter the following command:

```
-> aaa authentication http local
```

You cannot specify more than one session type in a single command line. However, you can still unlock multiple session types by using the **aaa authentication** command in succession. For example:

```
-> aaa authentication http local
-> aaa authentication telnet local
-> aaa authentication ftp local
```

Refer to the *OmniSwitch CLI Reference Guide* for complete **aaa authentication** command syntax options.

Changing the Login Password

Change the login password for **admin** user sessions by following the steps below:

- 1 Be sure that you have logged into the switch as user type **admin** (see [“Logging In to the Switch” on page 2-6](#)).
- 2 Enter the keyword **password** and press **Enter**.
- 3 Enter your new password at the prompt.

Note. Be sure to remember or securely record all new passwords; overriding configured passwords on an OmniSwitch is restricted.

- 4 You will be prompted to re-enter the password. Enter the password a second time.

New password settings are automatically saved in real time to the local user database; the user is not required to enter an additional command in order to save the password information. Also note that new password information is retained following a reboot. All subsequent login sessions, including those through the console port, will require the new password to access the switch.

For detailed information on managing login information, including user names and passwords, refer to the *OmniSwitch AOS Release 6 Switch Management Guide*.

Setting the System Time Zone

The switch's default time zone is UTC. If you require a time zone that is specific to your region, or if you need to enable Daylight Savings Time (DST) on the switch, you can configure these settings via the **system timezone** and **system daylight-savings-time** commands.

For detailed information on configuring a time zone for the switch, refer to the *OmniSwitch AOS Release 6 Switch Management Guide*.

Setting the Date and Time

Set the current time for the switch by entering **system time**, followed by the current time in *hh:mm:ss*.

To set the current date for the switch, enter **system date**, followed by the current date in *mm/dd/yyyy*.

Setting Optional Parameters

Specifying an Administrative Contact

An administrative contact is the person or department in charge of the switch. If a contact is specified, users can easily find the appropriate network administrator if they have questions or comments about the switch.

To specify an administrative contact, use the **system contact** command.

Specifying a System Name

The system name is a simple, user-defined text description for the switch.

To specify a system name, use the **system name** command.

Specifying the Switch's Location

It is recommended that you use a physical labeling system for locating and identifying your switch(es). Examples include placing a sticker or placard with a unique identifier (e.g., the switch's default IP address) on each chassis.

However, if no labeling system has been implemented or if you need to determine a switch's location from a remote site, entering a system location can be very useful.

To specify a system location, use the **system location** command.

Viewing Your Changes

To view your current changes, enter **show system** at the CLI prompt.

Saving Your Changes

Once you have configured this basic switch information, save your changes by entering **write memory** at the CLI command prompt.

3 OmniSwitch 6250 Chassis and Hardware Components

OmniSwitch 6250 switches are available in the chassis configurations as shown in the table below:

- OmniSwitch 6250-8M (OS6250-8M) Eight port stackable Metro model.
- OmniSwitch 6250-24M (OS6250-24M) Twenty-four port stackable Metro model.
- OmniSwitch 6250-24MD (OS6250-24MD) Twenty-four port stackable Metro model with DC power.
- OmniSwitch 6250-24 (OS6250-24) Twenty-four port stackable Enterprise model.
- OmniSwitch 6250-P24 (OS6250-P24) Twenty-four port stackable Enterprise model with PoE.

This chapter includes detailed information on these chassis types. Topics include:

- OmniSwitch 6250 chassis descriptions
- Technical specifications
- Power Supplies
- Stacking cables and power cords
- Console port and pinout specifications

OmniSwitch 6250-8M

The OS6250-8M chassis contains the following major components:





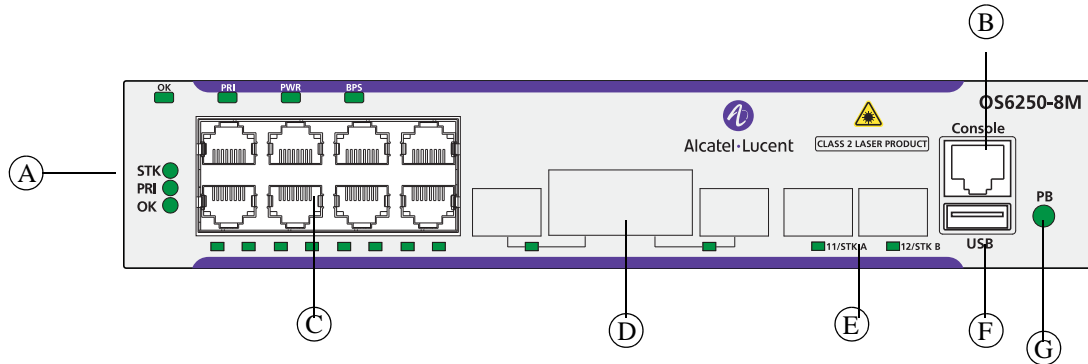

- System status LEDs
- (8) Unshared 10/100Base-T ports
- (2) Non-combo 100/1000BaseX or SFP+ Stacking ports
- (2) Combo 10/100/1000Base-T or 100/1000BaseX ports
- Internal AC Power Supply
- Console port (RJ-45)
- USB port (USB 2.0)

Note. USB port is not supported in this release.

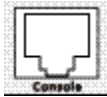
OmniSwitch 6250-8M Front Panel



OS6250-8M Front Panel

Item	Description	
A	System Status LEDs Provides status on hardware, software, stacking and power.	
B	Console Port RS-232 console port with an RJ-45 connector. Provides access to the CLI for configuration and management.	
C	10/100BaseT RJ-45 Ports 10/100BaseT non-combo ports. Odd-numbered ports are on top row, even-numbered ports are on bottom row.	
D	10/100/1000BaseT or 100/1000BaseX SFP Combo Ports Two 10/100/1000BaseT or SFP combo ports for various supported SFP transceivers.	
E	SFP Uplink or SFP+ Stacking Ports Two SFP or SFP+ ports to be used for uplink or stacking.	
F	USB Port High speed USB 2.0 port.	
G	Push Button When pushed all LEDs will turn off and the LED of the Stack ID will remain lit.	

Refer to [“LED Status” on page 3-20](#) for LED status information.

OmniSwitch 6250-8M Rear Panel

Note. The figure shows a pre-production version of the chassis without product, safety, and compliance information labels. All production versions of the chassis have these labels.

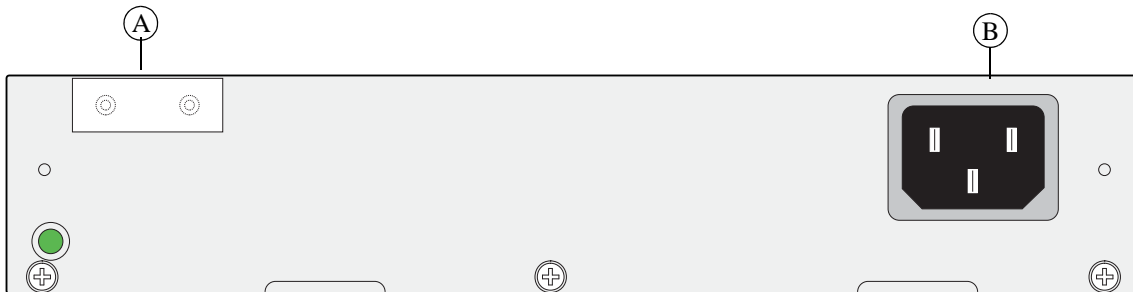

OS620-8M Rear Panel

Item	Description
A	Grounding Block Type LCD8-10A-L grounding lug
B	Power Supply Connector Internal AC power supply.

OS6250-8M Specifications

Total unshared 10/100BaseT ports per switch	8 (1-8)
Total combo ports per switch	2 (9-10)
Total non-combo SFP ports per switch	2 (11-12 in Uplink mode), (STK A, STK B Stacking mode)
Total 802.3af PoE ports per switch	N/A
Flash memory size	128 MB
RAM memory size	256 MB SDRAM
Chassis Width	8.5 inches (21.5 cm)
Chassis Height	1.73 inches (4.4 cm)
Chassis Height (rack units)	1 RU
Chassis Depth	11.5 inches (29.21 cm)
Weight	3.80 lbs (1.72kg)
Operating Humidity	5% to 95% non-condensing
Storage Humidity	10% to 95% non-condensing
Operating Temperature	0C to +45C
Storage Temperature	-40C to +70C
Data rate (RJ-45)	10 or 100 Mbps (full or half duplex) 1 Gigabit per second (full duplex)
Upper Threshold Temperature	85C
Danger Threshold Temperature	90C
Data rate (SFP)	100/1000 Mbps (full duplex)
Maximum frame size	9216 bytes
Cable supported (RJ-45)	10BaseT: unshielded twisted-pair (UTP) 100BaseTX: unshielded twisted-pair (UTP), Category 5, EIA/TIA 568 or shielded twisted-pair (STP), Category 5, 100 ohm 1000BaseT: unshielded twisted-pair (UTP), Category 5e
Maximum cable distance (RJ-45)	100 meters

OmniSwitch 6250-24M/24MD

The OS6250-24M chassis contains the following major components:



- System status LEDs
- (24) Unshared 10/100Base-T ports
- (2) Non-combo 100/1000BaseX or SFP+ Stacking Ports
- (2) Combo 10/100/1000Base-T or 100/1000BaseX
- Internal AC Power Supply (24M)
- Internal DC Power Supply (24MD)
- External BPS
- Console port (RJ-45)
- USB port (USB 2.0)

Note. USB port is not supported in this release.

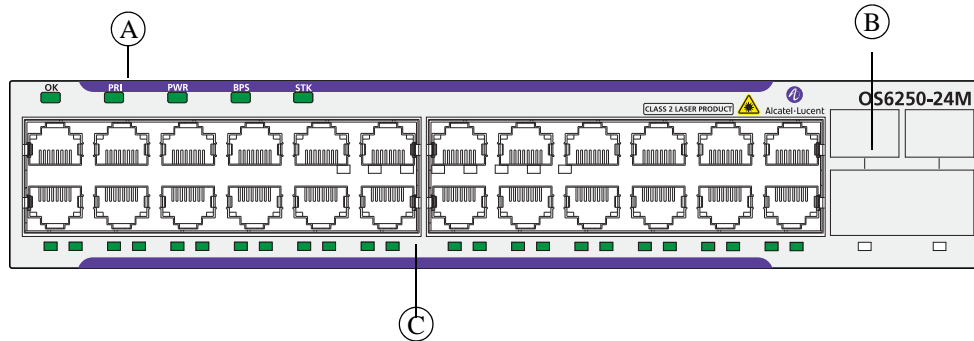
OmniSwitch 6250-24M/24-MD Front Panel

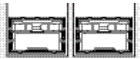

OS6250-24M/24-MD Front Panel

Item	Description
A	<p>System Status LEDs Provides status on hardware, software, primary and redundant power.</p> 
B	<p>10/100/1000BaseT or 100/1000BaseX SFP Combo Ports Two 10/100/1000BaseT or SFP combo ports for various supported SFP transceivers.</p> 
C	<p>10/100BaseT RJ-45 Ports 10/100BaseT non-combo ports. Odd-numbered ports are on top row, even-numbered ports are on bottom row.</p> 

Refer to [“LED Status” on page 3-20](#) for LED status information.

OmniSwitch 6250-24M/24-MD Rear Panel

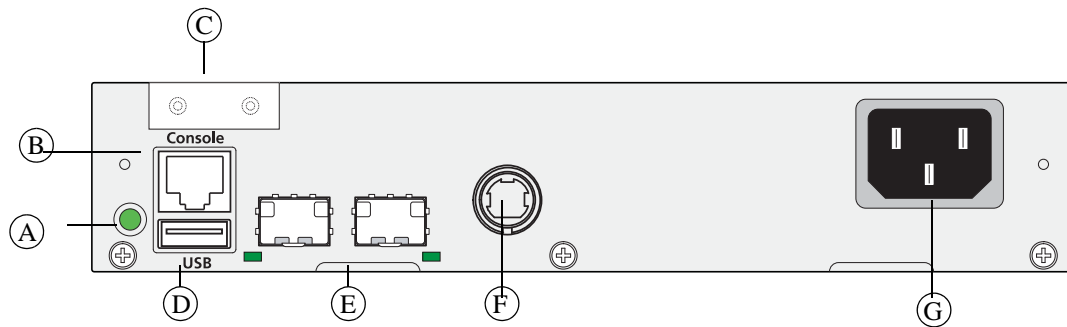

Note. The figure shows a pre-production version of the chassis without product, safety, and compliance information labels. All production versions of the chassis have these labels.



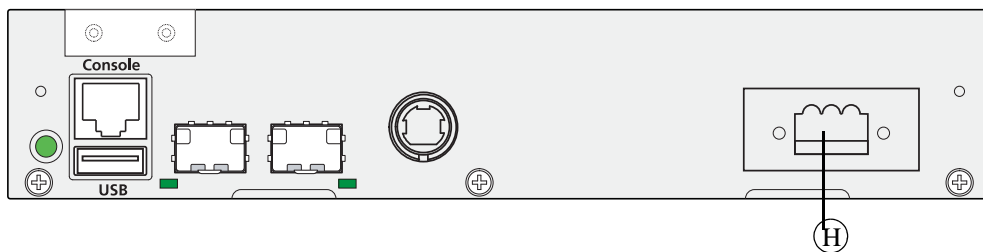

OS6250-24M Rear Panel



OS6250-24MD Rear Panel

Item	Description	
A	Push Button When pushed all LEDs will turn off and the LED of the Stack ID will remain lit.	
B	Console Port RS-232 console port with an RJ-45 connector. Provides access to the CLI for configuration and management.	
C	Grounding Block Type LCD8-10A-L grounding lug	
D	USB Port High speed USB 2.0 port.	

Item	Description	
E	SFP Uplink or SFP+ Stacking Ports Two SFP or SFP+ ports to be used for uplink or stacking.	
F	BPS Connector	
G	Power Supply Connector Internal AC power supply.	
H	DC Power Supply Connector	

Refer to [“LED Status” on page 3-20](#) for LED status information.

OS6250-24M/24-MD Specifications

Total unshared 10/100BaseT ports per switch	24 (1-24)
Total combo ports per switch	2 (25-26)
Total non-combo SFP ports per switch	2 (27-28 in Uplink mode), (STK A, STK B Stacking mode)
Total 802.3af PoE ports per switch	N/A
Flash memory size	128 MB
RAM memory size	256 MB SDRAM
Chassis Width	8.5 inches (21.5 cm)
Chassis Height	1.73 inches (4.4 cm)
Chassis Height (rack units)	1 RU
Chassis Depth	11.5 inches (29.21 cm)
Weight	3.80 lbs (1.72 kg)
Operating Humidity	5% to 95% non-condensing
Storage Humidity	10% to 95% non-condensing
Operating Temperature	0C to +45C
Storage Temperature	-40C to +70C
Upper Threshold Temperature	99C
Danger Threshold Temperature	105C
Data rate (RJ-45)	10 or 100 Mbps (full or half duplex) 1 Gigabit per second (full duplex)
Data rate (SFP)	100/1000 Mbps (full duplex)
Maximum frame size	9216 bytes
Cable supported (RJ-45)	10BaseT: unshielded twisted-pair (UTP) 100BaseTX: unshielded twisted-pair (UTP), Category 5, EIA/TIA 568 or shielded twisted-pair (STP), Category 5, 100 ohm 1000BaseT: unshielded twisted-pair (UTP), Category 5e
Maximum cable distance (RJ-45)	100 meters

OmniSwitch 6250-24

The front panel of the OS6250-24 chassis contains the following major components:



- System status LEDs
- (24) Unshared 10/100Base-T ports
- (2) Combo 10/100/1000Base-T or 100/1000BaseX
- (2) HDMI Stacking Ports
- Internal AC Power Supply
- External BPS
- Console port (RJ-45)
- USB port (USB 2.0)

Note. USB port is not supported in this release.

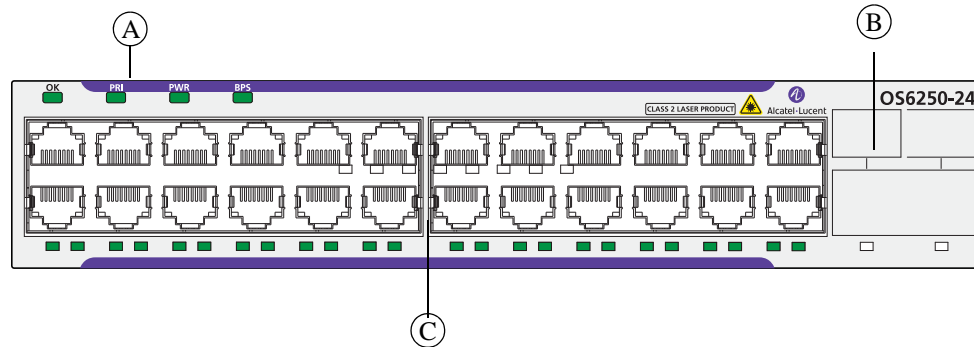
OmniSwitch 6250-24 Front Panel

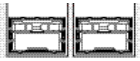

OS6250-24 Front Panel

Item	Description
A	<p>System Status LEDs Provides status on hardware, software, primary and redundant power.</p> 
B	<p>10/100/1000BaseT or 100/1000BaseX SFP Combo Ports Two 10/100/1000BaseT or SFP combo ports for various supported SFP transceivers.</p> 
C	<p>10/100BaseT RJ-45 Ports 10/100BaseT non-combo ports. Odd-numbered ports are on top row, even-numbered ports are on bottom row.</p> 



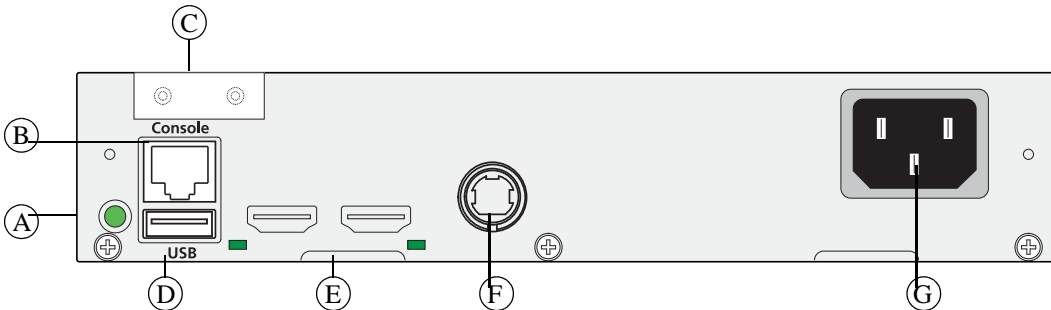

Refer to [“LED Status” on page 3-20](#) for LED status information.

OmniSwitch 6250-24 Rear Panel

Note. The figure shows a pre-production version of the chassis without product, safety, and compliance information labels. All production versions of the chassis have these labels.



OS6250-24 Rear Panel

Item	Description	
A	Push Button When pushed all LEDs will turn off and the LED of the Stack ID will remain lit.	
B	Console Port RS-232 console port with an RJ-45 connector. Provides access to the CLI for configuration and management.	
C	Grounding Block Type LCD8-10A-L grounding lug	
D	USB Port High speed USB 2.0 port.	
E	HDMI Stacking Connectors Connectors for use in stacking switches into a virtual chassis or as an uplink port.	
F	BPS Connector	
G	Power Supply Connector Internal AC power supply.	

Refer to [“LED Status” on page 3-20](#) for LED status information.

OS6250-24 Specifications

Total unshared 10/100BaseT ports per switch	24 (1-24)
Total combo ports per switch	2 (25-26)
Total HDMI ports per switch	2 (Stack A, Stack B)
Total 802.3af PoE ports per switch	N/A
Flash memory size	128 MB
RAM memory size	256 MB SDRAM
Chassis Width	8.5 inches (21.5 cm)
Chassis Height	1.73 inches (4.4 cm)
Chassis Height (rack units)	1 RU
Chassis Depth	11.5 inches (29.21 cm)
Weight	3.80 lbs (1.72 kg)
Operating Humidity	5% to 95% non-condensing
Storage Humidity	10% to 95% non-condensing
Operating Temperature	0C to +45C
Storage Temperature	-40C to +70C
Upper Threshold Temperature	98C
Danger Threshold Temperature	105C
Data rate (RJ-45)	10 or 100 Mbps (full or half duplex) 1 Gigabit per second (full duplex)
Data rate (SFP)	100/1000 Mbps (full duplex)
Maximum frame size	9216 bytes
Cable supported (RJ-45)	10BaseT: unshielded twisted-pair (UTP) 100BaseTX: unshielded twisted-pair (UTP), Category 5, EIA/TIA 568 or shielded twisted-pair (STP), Category 5, 100 ohm 1000BaseT: unshielded twisted-pair (UTP), Category 5e
Maximum cable distance (RJ-45)	100 meters

OmniSwitch 6250-P24

The front panel of the OS6250-P24 chassis contains the following major components:



- System status LEDs
- (24) Unshared 10/100Base-T PoE (802.3at first 6 ports and combo, 802.3af remaining ports) ports
- (2) Combo 10/100/1000Base-T or 100/1000BaseX
- (2) HDMI Stacking Ports
- External Power Supply
- External BPS
- Internal Fan
- Console port (RJ-45)
- USB port (USB 2.0)

Note. USB port is not supported in this release.

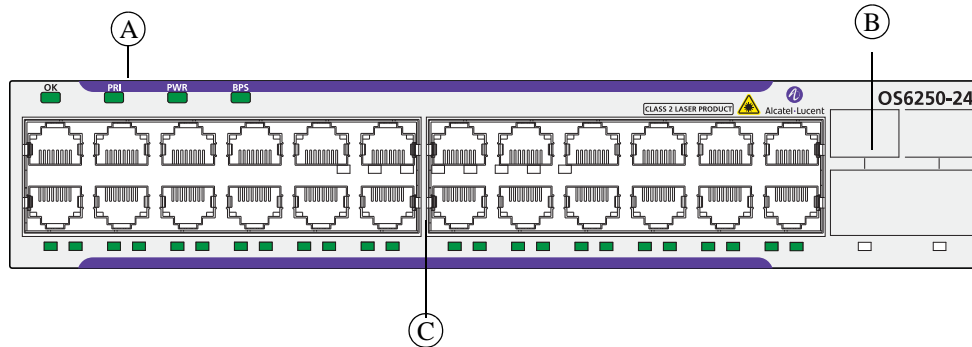
OmniSwitch 6250-P24 Front Panel

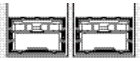

OS6250-P24 Front Panel - Update

Item	Description	
A	System Status LEDs Provides status on hardware, software, primary and redundant power.	
B	10/100/1000BaseT or 100/1000BaseX SFP Combo Ports Two 10/100/1000BaseT or SFP combo ports for various supported SFP transceivers.	
C	10/100BaseT RJ-45 Ports 10/100BaseT non-combo ports. Odd-numbered ports are on top row, even-numbered ports are on bottom row.	



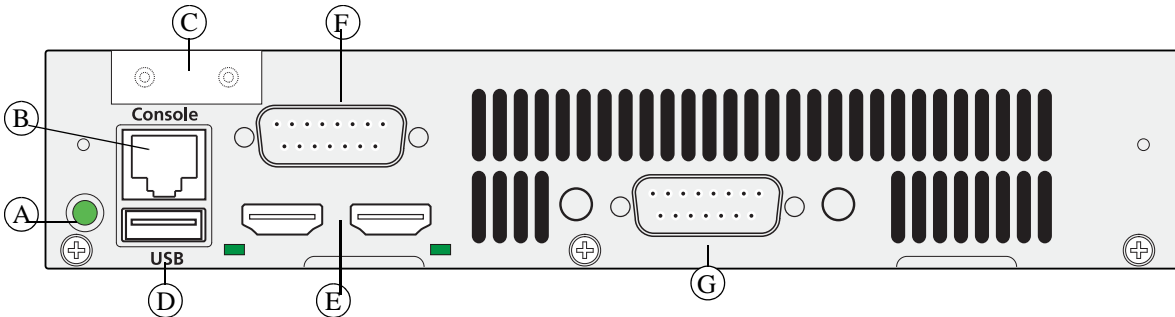

Refer to [“LED Status” on page 3-20](#) for LED status information.

OmniSwitch 6250-P24 Rear Panel

Note. The figure shows a pre-production version of the chassis without product, safety, and compliance information labels. All production versions of the chassis have these labels.



OS6250-P24 Rear Panel

Item	Description	
A	Push Button When pushed all LEDs will turn off and the LED of the Stack ID will remain lit.	
B	Console Port RS-232 console port with an RJ-45 connector. Provides access to the CLI for configuration and management.	
C	Grounding Block Type LCD8-10A-L grounding lug	
D	USB Port High speed USB 2.0 port.	
E	HDMI Stacking Connectors Connectors for use in stacking switches into a virtual chassis or as an uplink port.	
F	Backup Power Supply Connector	
G	Main Power Supply Connector	

Refer to [“LED Status” on page 3-20](#) for LED status information.

OS6250-P24 Specifications

Total unshared 10/100BaseT ports per switch	24 (1-24)
Total combo ports per switch	2 (25-26)
Total HDMI ports per switch	2 (StackA, StackB)
Total 802.3at PoE ports per switch	8 (1-6, 25-26) Ports 25 and 26 share PoE with 23 and 24. Only one set of ports can have PoE operational at a time.
Total 802.3af PoE ports per switch	18 (7-24) Ports 23 and 24 share PoE with 25 and 26. Only one set of ports can have PoE operational at a time.
Flash memory size	128 MB
RAM memory size	256 MB SDRAM
Chassis Width	8.5 inches (21.5 cm)
Chassis Height	1.73 inches (4.4 cm)
Chassis Height (rack units)	1 RU
Chassis Depth	11.5 inches (29.21 cm)
Weight	4.20 lbs (1.91kg)
Operating Humidity	5% to 95% non-condensing
Storage Humidity	10% to 95% non-condensing
Operating Temperature	0C to +45C
Storage Temperature	-40C to +70C
Upper Threshold Temperature	86C
Danger Threshold Temperature	91C
Data rate (RJ-45)	10 or 100 Mbps (full or half duplex) 1 Gigabit per second (full duplex)
Data rate (SFP)	100/1000 Mbps (full duplex)
Maximum frame size	9216 bytes
Cable supported (RJ-45)	10BaseT: unshielded twisted-pair (UTP) 100BaseTX: unshielded twisted-pair (UTP), Category 5, EIA/TIA 568 or shielded twisted-pair (STP), Category 5, 100 ohm 1000BaseT: unshielded twisted-pair (UTP), Category 5e
Maximum cable distance (RJ-45)	100 meters

LED Status

LED	State	Description
OK	Solid Green	Normal Operation.
	Blinking Green	Boot up/Remote Config Load in Progress
	Solid Amber	Operating Temperature Exceeded.
PRI	Solid Green	Primary unit in a stack or standalone switch.
	Solid Amber	Secondary unit in a stack.
	Off	Switch is idle. (not primary or secondary)
PWR	Solid Green	P/S Normal Operation.
	Amber	P/S Present and Bad (24-port models only)
	Off	P/S Not Present or Bad.
BPS	Solid Green	P/S Normal Operation.
	Amber	P/S Present and Bad (24-port models only)
	Off	P/S Not Present or Bad.
STK	Green	Unit in Stacking Mode
	Amber	Unit in Standalone Mode
Stack A/ Stack B	Green	Valid Uplink
	Amber	Valid Stacking Link
	Off	No Link Detected.
10/100/1000 Ports	Solid Green	Valid Link
	Blinking Green	Transmitting or receiving packets in a link up state for non-PoE .
	Solid Amber	Valid PoE Link.
	Blinking Amber	Transmitting or receiving packets in a link up state for PoE .
	Off	No Link Detected.
SFP Ports	Solid Green	Valid Link.
	Blinking Green	Transmitting or receiving packets in a link up state .
	Off	No Link Detected.
Push Button Operation		When pushed all LEDs will turn off and the LED of the Stack ID will remain lit.

OS6250 - Power Supplies

- Internal 30W AC System Power Supply (see [“Internal AC Power Supply”](#) on page 3-22)
- Internal 30W DC System Power Supply (see [“Internal DC Power Supply”](#) on page 3-23)
- External 42W AC Power Brick (see [“PS-42W-AC Power Brick”](#) on page 3-24)
- External 30W DC Power Brick (see [“PS-30W-DC Power Brick”](#) on page 3-25)
- External 225W AC PoE Power Supply (see [“PS-225W-AC-P PoE Power Supply Module”](#) on page 3-26)

Internal AC Power Supply

Provides system power for the OmniSwitch 6250 switches.

P/S Component	Description
Model	Internal AC Power Supply
Provides System Power For	OS6250-8M/24/24M
Input Voltage Range	100-240 VAC
Rated Frequency	50 to 60 Hz
Inrush Current	0.9 A
Maximum Output Power	30 W
Output Voltage	12.0 VDC
Output Current	2.5 A (maximum)

Internal DC Power Supply

Provides system power for the OmniSwitch 6250 switches.

P/S Component	Description
Model	Internal DC Power Supply
Provides System Power For	OS6250-24MD
Input Voltage Range	-40 to -60VDC
Input Current	2.0 A
Maximum Output Power	30 W
Output Voltage	12.0 VDC
Output Current	2.5 A (maximum)

PS-42W-AC Power Brick

Provides system power and can be installed as a redundant system power supply.

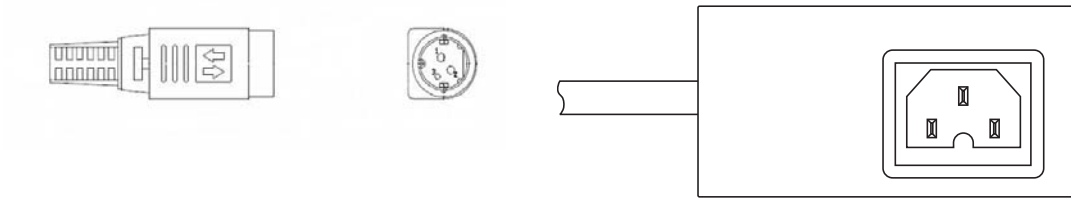

42W, AC Power Brick

P/S Component	Description
Model	PS-42W-AC
Provides Redundant System Power For	OS6250-24/24M/24MD
Input Voltage Range	100-240 VAC
Rated Frequency	50 to 60 Hz
Input Current	1.1 A (maximum)
Maximum Output Power	42W
Output Voltage	12 VDC
Output Current	3.5 A (maximum)

PS-30W-DC Power Brick

Provides system power and can be installed as a redundant system power supply.

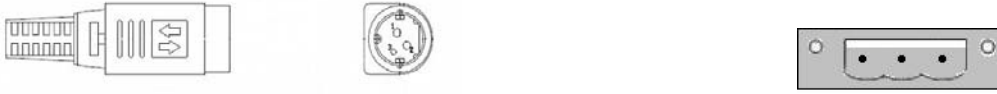

30W, 24/-48VDC System Power Brick

P/S Component	Description
Model	PS-30W-DC
Provides Redundant System Power For	OS6250-24/24M/24MD
Input Voltage Range	-40 to -60 VDC
Input Current	2 A
Maximum Output Power	30 W
Output Voltage	12.0 VDC
Output Current	2.5 A (maximum)

PS-225W-AC-P PoE Power Supply Module

Provides system and Power over Ethernet and can be installed as either the primary or backup power supply.

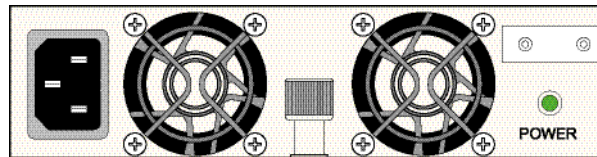
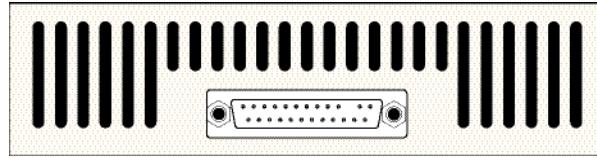

225W, -54.5VDC PoE Power Brick

P/S Component	Description
Model	PS-225W-AC-P
Provides System and PoE Power For	OS6250-P24
Input Voltage Range	100 to 240 VAC
Rated Frequency	50 to 60 Hz
Input Current	3.6A (maximum)
Maximum Output Power	225W
Output Voltage / Current	54.5 VDC @ 3.5A, 12V @ 3A

Power Supply Tray

Alcatel-Lucent requires the use of the power supply tray when connecting external power supplies. The shelf can be attached directly to the back or side of the chassis and rack mounted.

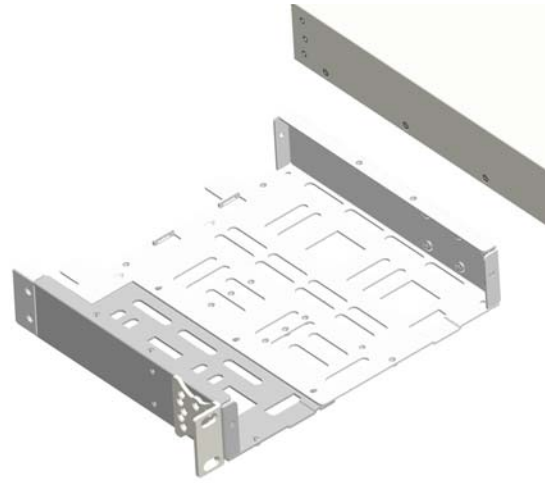
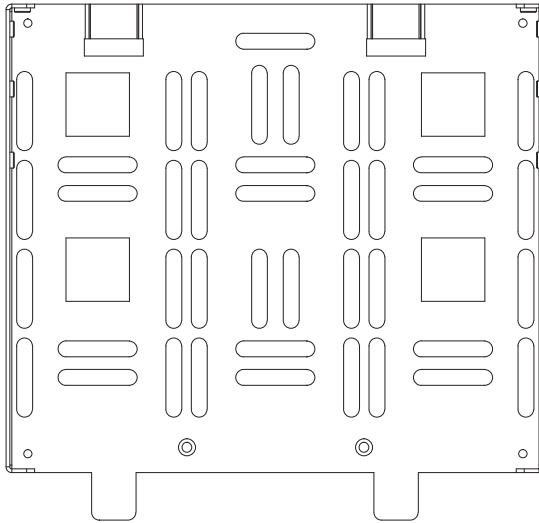

OS6250 Power Supply Shelf

Power Supply Tray Specifications

Tray Width	8.125 inches
Tray Height	1.73 inches
Tray Height (rack units)	1 RU
Tray Depth	8.25 inches
Weight	2.0 lbs

Note: Side section of tray can be removed to provide access channel to rear of chassis when rack-mounting units on top of each other.

AC Power Cords

Since the power cord is the switch's only disconnect device, it should be plugged into an easily accessible outlet. In the event that your power cord is lost or damaged, refer to the specifications below.

Specifications

The power cord included with this product contains three (3) insulated #18AWG stranded copper wires and is rated between 85-265 VAC (region dependent), 10 amps with a nominal length of 2 meters. The female end terminates in an IEC-60320-C15 attachment plug and the male end termination varies dependent upon region, as listed below.

European cords must be Harmonized (HAR) type. Refer to the information below for power plug types by region:

Power Cord Types	User Side Connectors
North America	NEMA 5-15-P
United Kingdom / Ireland	BS 1363 UK
Europe	CEE 7/7
Japan	JIS 8303
Australia	AS 3112
India	BS 546
Italy	CIE 23-16
Switzerland / Liechtenstein	SEV 1011
Denmark / Greenland	SRAF 1962 / DB 16/87
Argentina	A-10



IEC-60320-C15

Supplied 6250 Power Cord Specifications

DC Power Specifications

OS6250-24MD Internal DC Power Supply

The internal DC power supply has the following additional considerations. Refer to the installation steps described in [“OS6250-24MD Internal DC Power Supply Connections” on page 4-27](#)

- Connect to a -48V or -60V reliably grounded DC SELV source.
- Use common DC return connections for the DC power supplies. The DC return terminal conductor should be connected to the equipment frame.
- The Branch Circuit Overcurrent Protection must be rated a Maximum of 15A.
- Use 12AWG solid copper conductors only.
- A readily accessible disconnect device that is suitably approved and rated shall be incorporated in the field wiring.

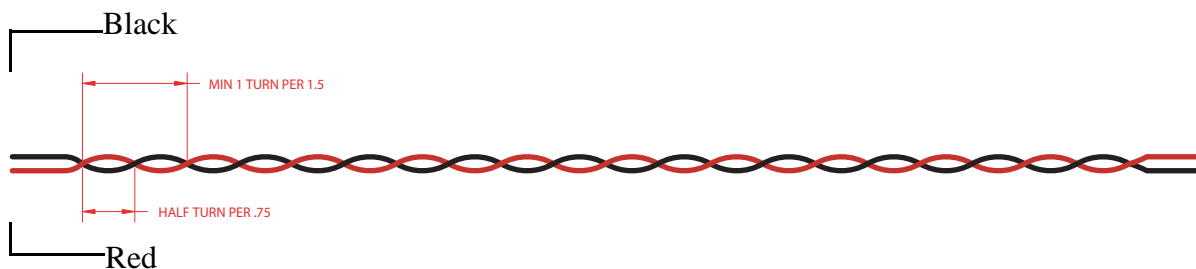

Twisted pair wire (red and black) for a DC power supply

Backup DC Power Brick

The backup DC power brick has the following additional considerations. Refer to the installation steps described in [“OS6250-24MD Internal DC Power Supply Connections” on page 4-27](#)

- Connect to a -48V or -60V reliably grounded DC SELV source.
- Use common DC return connections for the DC power supplies. The DC return terminal conductor should be connected to the equipment frame.
- The Branch Circuit Overcurrent Protection must be rated a Maximum of 5A.
- Use 22AWG solid copper conductors only.
- A readily accessible disconnect device that is suitably approved and rated shall be incorporated in the field wiring.

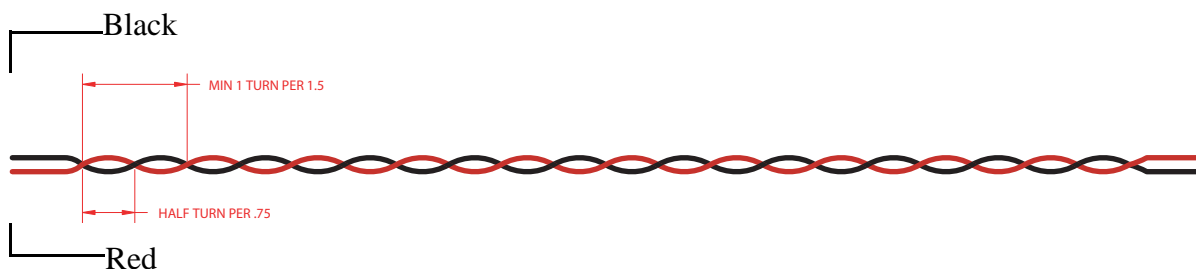

Twisted pair wire (red and black) for a DC power supply

Stacking Cables

The following cables and transceivers can be used for stacking switches into a virtual chassis. Depending on the length and stacking requirements, either copper or fiber can be used. Enterprise models support two HDMI stacking ports and Metro models support two SFP+ stacking ports for use with SFP+ direct attached copper cables.

Cable Types	Lengths
Copper - SFP+ Direct Attached (Metro Models)	30/60/150 centimeters
HDMI (Enterprise Models)	30/60/150 centimeters

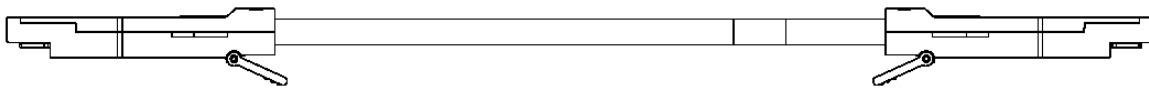

SFP+ Direct Attached Copper- Squeeze Tab

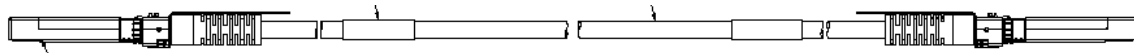

SFP+ Direct Attached Copper - Pull Tab

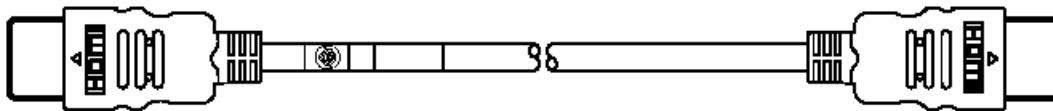

HDMI Stacking Cable

Console Port

The console port, located on the chassis front panel, provides a console connection to the switch and is required when logging into the switch for the first time. By default, this RJ-45 connector provides a DTE console connection.

Serial Connection Default Settings

The factory default settings for the serial connection are as follows:

baud rate	9600
parity	none
data bits (word size)	8
stop bits	1
flow control	none

Port Pinouts

RJ-45 Console Port – Connector Pinout

Pin Number	Signals as DTE Console Port
1	NC
2	NC
3	RXD
4	Ground
5	Ground
6	TXD
7	NC
8	NC

10/100 Ethernet Port – RJ-45 Pinout (non-PoE)

Pin Number	Description
1	RX+
2	RX-
3	TX+
4	not used
5	not used
6	TX-
7	not used
8	not used

Gigabit Ethernet Port – RJ-45 Pinout

Pin Number	Description
1	BI_DB+
2	BI_DB-
3	BI_DA+
4	BI_DD+
5	BI_DD-
6	BI_DA-
7	BI_DC+
8	BI_DC-

10/100/1000 Mbps Power over Ethernet Port – RJ-45 Pinout

Pin Number	Description
1	RX+ (-VDC)
2	RX- (-VDC)
3	TX+ (+VDC)
4	
5	
6	TX- (+VDC)
7	
8	

Overtemp Condition

The OmniSwitch 6250 is designed to operate within a specified operating temperature as noted under the specifications section. However, in the event that the normal operating temperature of the switch is exceeded, the following will occur:

- Upon crossing the configured Upper Threshold, a trap will be sent. (See the *OmniSwitch Network Configuration Guide* for information on configuring switch thresholds).

If the temperature continues to rise and reaches the Danger Threshold, the following will occur:

- OK LED will display solid Amber.
- The switch will automatically shutdown
- Once the temperature drops to an acceptable operating level, the switch will automatically restart.

Check the following if an overtemp condition exists:

- Verify that the switch is installed properly in an environment that adheres to the installation instructions in the following chapters.
- Verify proper airflow to the chassis.

Dying Gasp

If the switch loses all power it will maintain power long enough to send a Dying Gasp message before completely shutting down. An SNMP trap, Syslog message and Link OAM PDUs will be generated.

Scenarios

A Dying Gasp event will be generated in the following scenarios:

- Primary power supply failure (if only power supply present).
- Primary power supply failure and then backup power supply failure.
- Backup power supply failure and then primary power supply failure.
- When a **reload** command is issued.
- When a **takeover** command is issued.

Note. Dying gasp will not work when both primary and backup power supplies fail simultaneously. Connect each power supply to a separate independent power source to avoid simultaneous power failures.

SNMP Trap

As soon as the power failure is detected, an SNMP trap is sent to the first three configured SNMP stations. The trap includes the following information:

- Slot number
- Power supply type (primary/backup)
- Time of the failure

Use the [snmp station](#) command and refer to the SNMP Configuration chapter for information on configuring an SNMP station.

Syslog Message

As soon as the power failure is detected, a Syslog message is sent to the first four configured Syslog servers. The message includes the following information:

- Syslog message "Dying Gasp Power Failure Event Occurred" along with the time of the failure.

Use the [swlog output socket](#) command and refer to the Using Switch Logging Configuration chapter for information on configuring a Syslog server.

Link OAM PDU

As soon as the power failure is detected an 802.3ah OAM Information PDU is sent to all ports for which link OAM is enabled and the LinkOAM port status is operational. The PDU will have the Dying Gasp bit set.

Use the `efm-oam` and `efm-oam port propagate-events` commands to enable the generation of an 802.3ah OAM Information PDU upon a dying gasp event:

```
-> efm-oam enable
-> efm-oam port 2/1-10 propagate-events dying-gasp enable
```

Link OAM PDU Priority

It may not be possible to generate PDUs on all ports enabled for link OAM. Dying gasp packets will be sent in the following order based on port priority:

1. Uplink ports
2. Combo ports
3. All other ports

4 Mounting OS6250 Switches

This chapter covers different mounting and installation options for OS6250 switches.

Anti-Static Warning. Before handling any components, free yourself of static by wearing a grounding strap, or by grounding yourself properly. Static discharge can damage the switch and the backup power supply.

Chassis Components

OmniSwitch 6250 switches ship with all mounting brackets attached. The following diagram shows the individual chassis and power supply tray components.

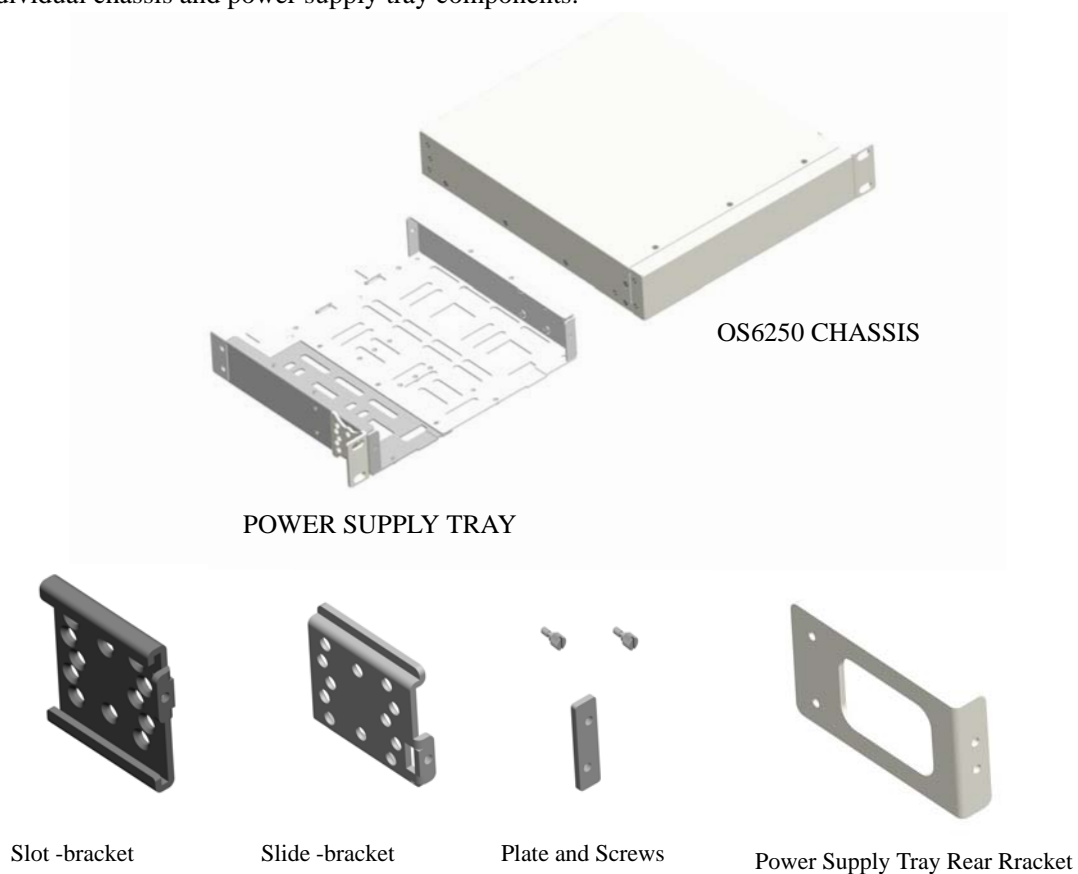

Factory-Shipped Chassis and Power Supply Tray Assemblies

Available Mounting Kits

The mounting kits listed below are available.

Kit	Description
OS6250-RM-19	Universal 1/2 width tray kit for mounting one 1/2 width OS6250 switch in a 19" rack.
OS6250-DUAL-MNT	Two mounting and sliding brackets to mount two OS6250 switches in a 19" rack.
OS6250-RM-19-L	Simple L-bracket for mounting one OS6250 switch in a 19" rack.
OS6250-REAR-MNT	Mounting brackets to stabilize the rear of unit in the back of a 19" rack. Hardware to mount the rear of two 6250 units in a 19" rack.
OS6250-WALL-MNT	Wall mounting kit for OS6250-8M only. Contains universal mounting brackets and screws for wall mounting an OS6250-8M.

General Installation Recommendations

Cooling Recommendations

OS6250 non-PoE switches are convection-cooled. Although air flow is not mandatory for switch operation, *the best way to ensure proper cooling is to provide some ambient air flow over the switch whenever possible* (e.g., from room fans, etc.).

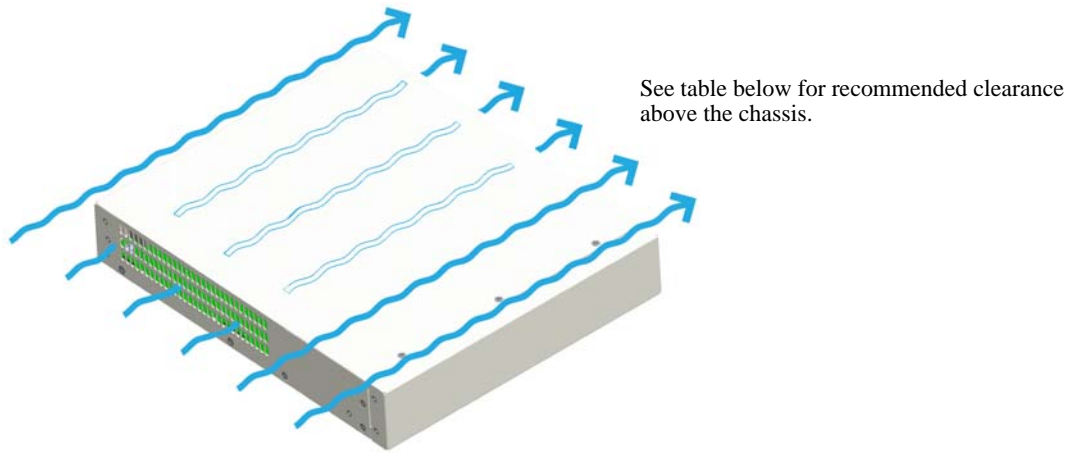

Recommended Airflow Through Chassis - non-PoE Models

OS6250 PoE switches contain a fan that draws air over the internal components for proper cooling as shown in the diagram below. Fans pull air into the left side. Air is vented through the right side and rear of the chassis.

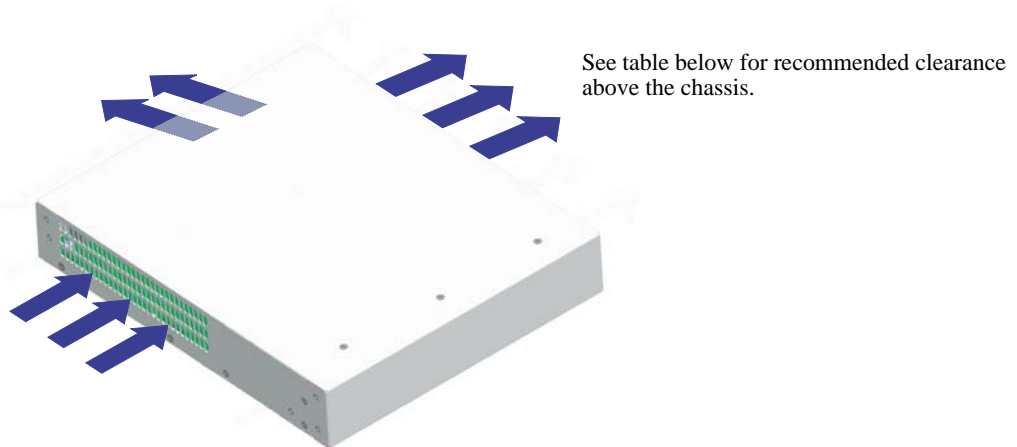

Airflow Through Chassis - PoE Model

Reduced Air Flow

Installation of the equipment in a rack should be such that the amount of air flow required for safe operation of the equipment is not compromised.

Elevated Operating Ambient Temperatures

If installed in a closed or multi-unit rack assembly, the operating ambient temperature of the rack environment may be greater than room ambient. Therefore, consideration should be given to installing the equipment in an environment compatible with the maximum ambient temperature (T_{ma}) specified by the manufacturer.

Recommended Clearances

Always allow adequate clearance at the front, rear, top, and sides of the switch. The following table shows the recommended minimum clearances for adequate chassis cooling and access to cabling and components at the front and rear of the chassis.

Location	OS6250
Top	0.875 inches (1/2 RU)
Bottom	No minimum clearance required. However, be sure that the bottom of the chassis is not in direct contact with any equipment below.
Sides	2 inches
Rear	6 inches (see note below)
Front	6 inches (see note below)

Note. Clearance recommendations at the front and rear of chassis are for access to cabling and components only and are not intended as a specific airflow requirement.

Mechanical Loading

Mounting of the equipment in the rack should be such that a hazardous condition is not achieved due to uneven mechanical loading.

Circuit Overloading

Consideration should be given to the connection of the equipment to the supply circuit and the effect that overloading of the circuit might have on overcurrent protection and supply wiring. Appropriate consideration of equipment nameplate ratings should be used when addressing this concern.

Reliable Earthing

Reliable earthing of rack-mount equipment should be maintained. Particular attention should be given to supply connections other than direct connections to the branch circuit (e.g. use of power strips).

Power Supply Information

Before getting started, please note that OmniSwitch 6250 power supplies can be installed in a number of different configurations. For example:

- Non-redundant system power - Provides power requirements to the chassis, with no power supply redundancy/failover.
- Redundant system power - Provides power requirements to the chassis as well as power supply redundancy/failover.
- Non-redundant system and Power over Ethernet (PoE) - This provides power requirements to the chassis, as well as power requirements to the PoE ports.
- Redundant system and Power over Ethernet (PoE) - This provides power requirements to the chassis and PoE ports as well as power supply redundancy/failover to both chassis and PoE.

Refer to the table below for typical power supply and power supply tray requirements for different configurations.

Power requirements	External Power supplies needed	Power supply trays needed
Non-redundant with internal power	0	0
Redundant with internal power	1	1
Non-redundant without internal power	1	1
Redundant without internal power	2	2

Assembling OS6250 Switches

Assembly Guidelines

Depending on the model, power supplies, and mounting requirements, the OS6250 can be mounted in a variety of ways.

- Power supply trays can be mounted on the side or back of the chassis or both.
- Two chassis can be mounted side-by-side for rack mounting.
- Power supply trays can be mounted to the rear of the chassis.

Attaching the Power Supply Tray on Side of Chassis

When rack mounting a single switch, the power supply tray can be positioned at the side of the unit assembly. This allows the chassis and power supply tray assembly to span the full width of the rack.

If two external power supplies are to be used an additional power supply tray must be mounted immediately behind the switch chassis. Refer to the table on [page 4-5](#) for additional power supply requirements.

OS6250-RM-19 - Power supply tray side installation

A chassis and power supply tray can be assembled side-by-side to fit into a standard 19-inch rack mount as show in the figure below.

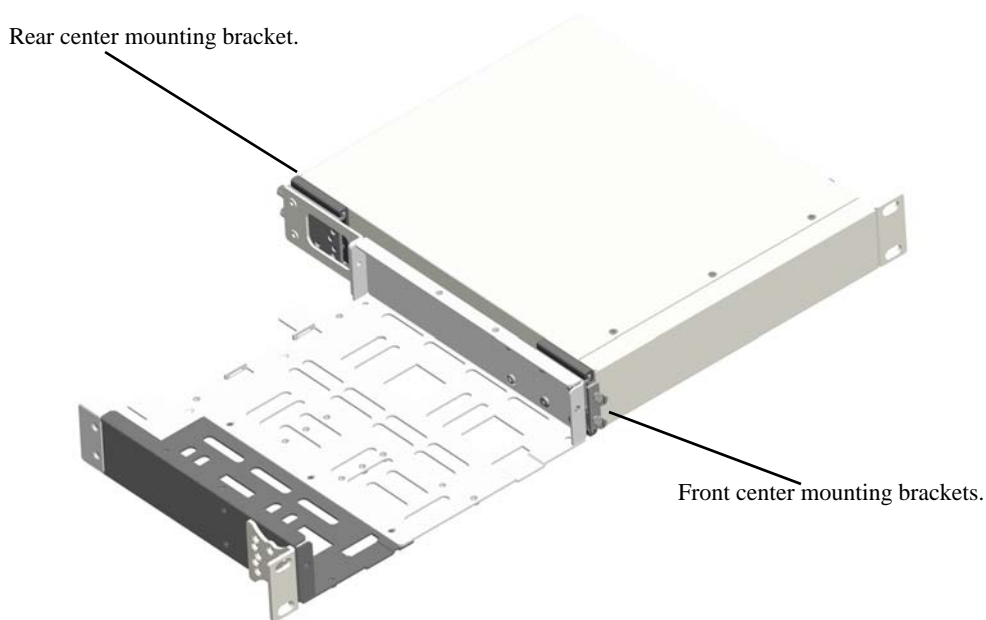

Fully Assembled Chassis and Power Supply Tray (OS6250-RM-19)

- 1 Attach the slot-brackets to the front and rear of the chassis using the attachment screws (M3 flathead) provided for each bracket.

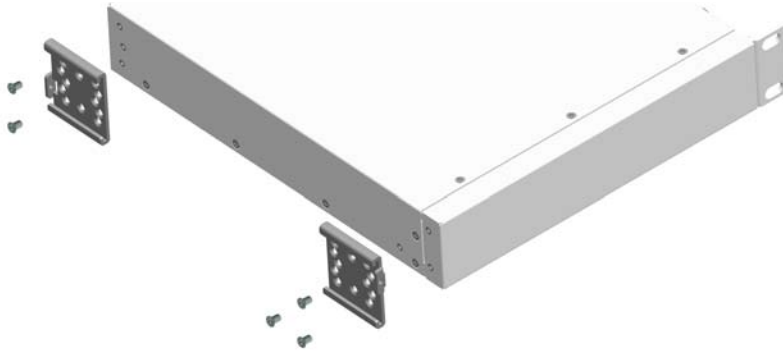

Slot-Bracket Attachment

- 2 Attach slide-bracket to front of the power supply tray using the attachment screws (M3 flathead).

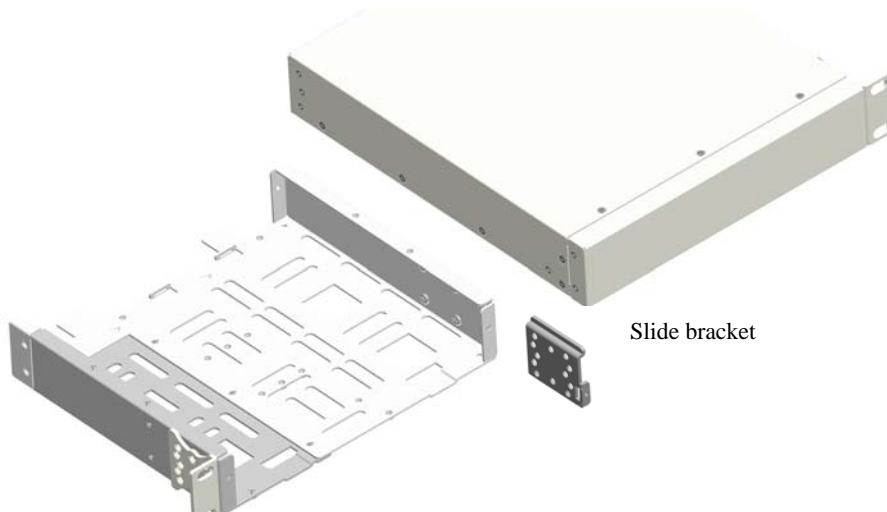

Slide-Bracket Attachment

- 3 Attach the power supply tray extension bracket to the rear of the power supply tray using one screw (M3 pan head) and then attach the slide bracket to the extension with two screws (M3 flathead).

Attach power supply tray extension bracket to the rear of the chassis.

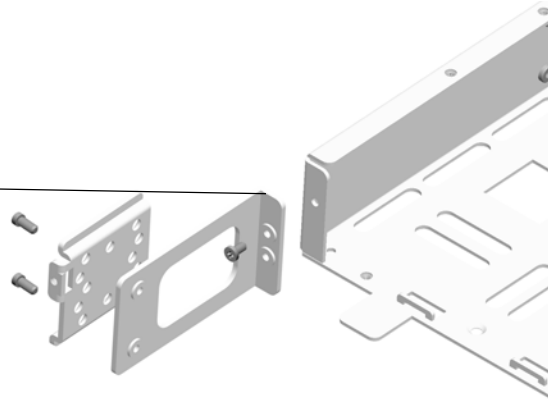

Power Supply Tray Extension Bracket

- 4 Slide the power supply tray and chassis together.

Slide the power supply tray extension into slot-bracket on chassis.

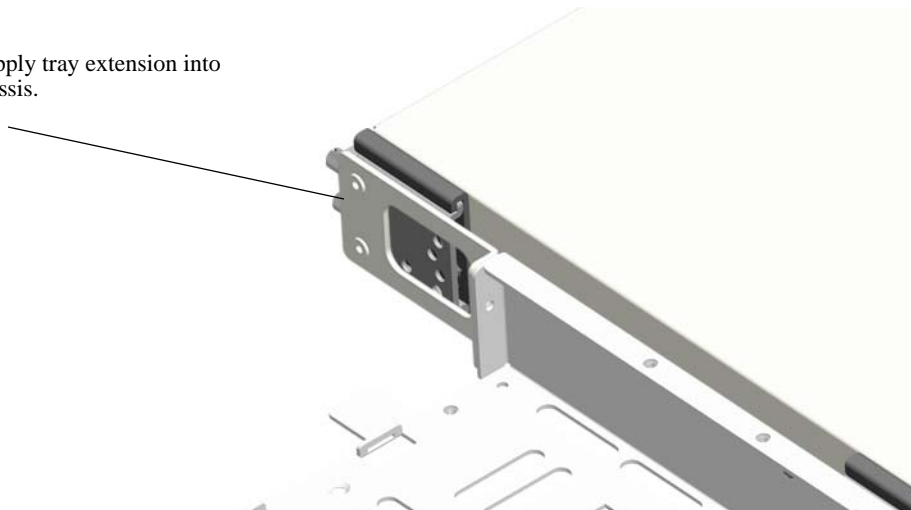

Power Supply Tray Extension Bracket with Slide Bracket

- 5 Place bracket plate over the front brackets and secure with thumb screws.

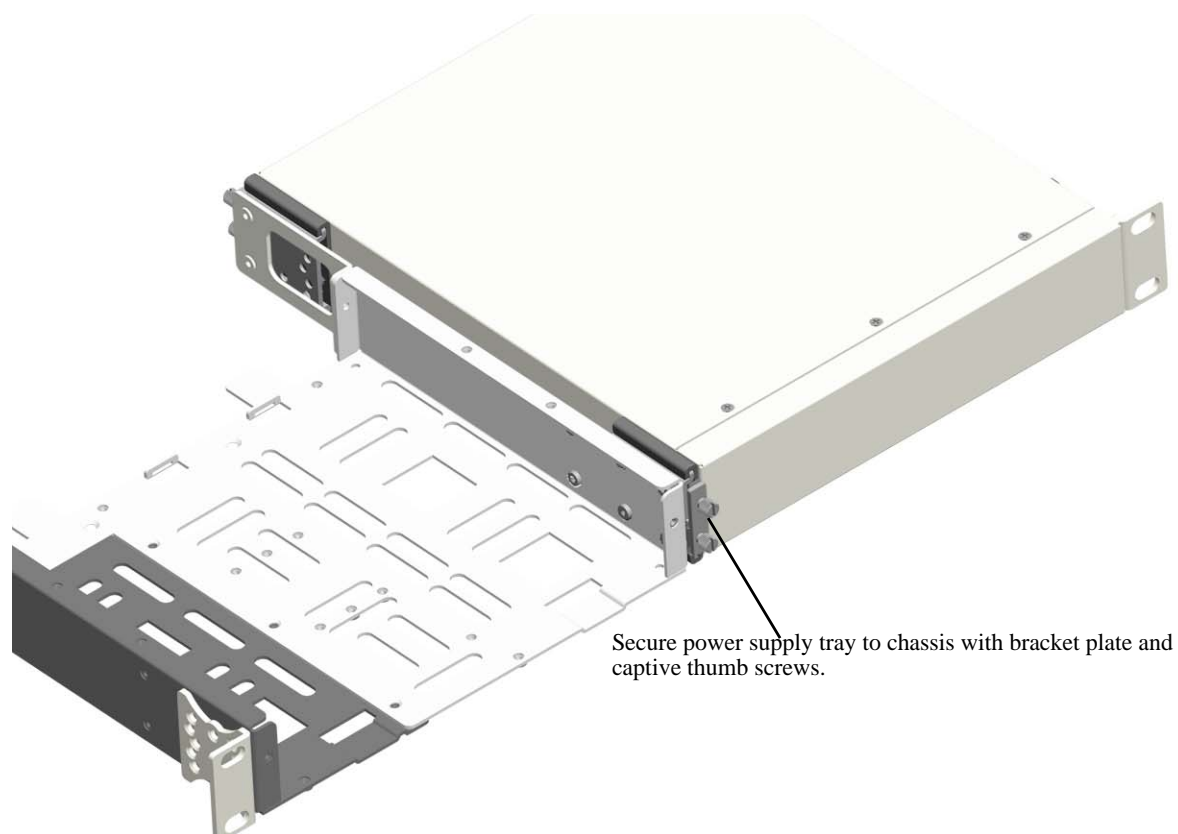

Secure Front Bracket with Plate

Skip to [“Securing Power Supplies in Power Supply Tray”](#) on page 4-13

OS6250-DUAL-MNT - Attaching Two Chassis Side-by-Side

Two chassis can be assembled side-by-side with the power supply trays attached to the back of the chassis, if necessary, for mounting into a standard 19-inch rack as show in the figure below.

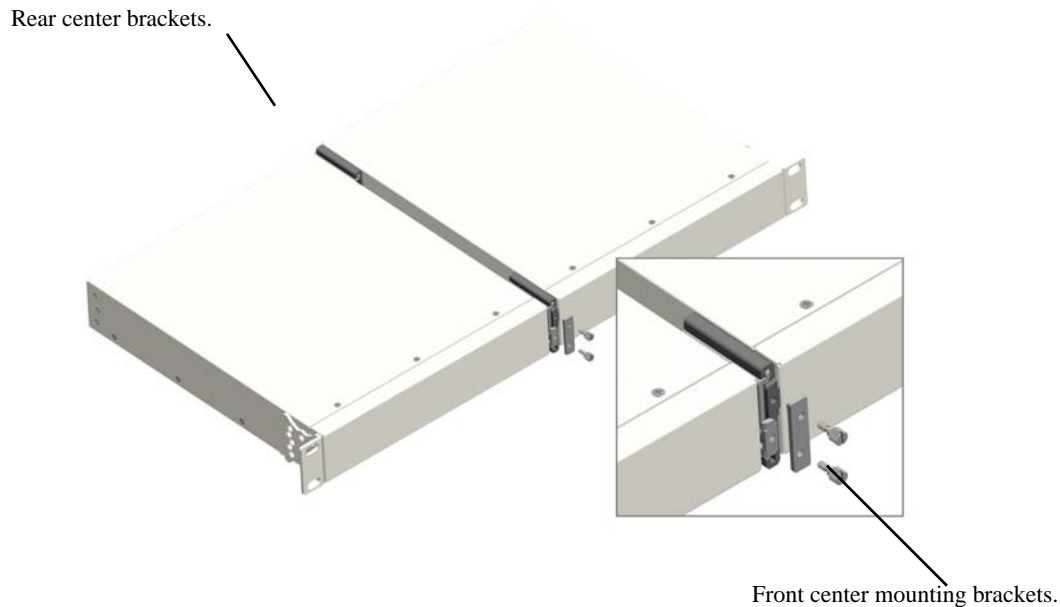

Fully Assembled Side-by-Side Chassis Assembly (OS6250-DUAL-MNT)

1 Attach the slot-brackets and slide-brackets to the front and back of the chassis using the attachment screws (M3 flat head) provided for each bracket.

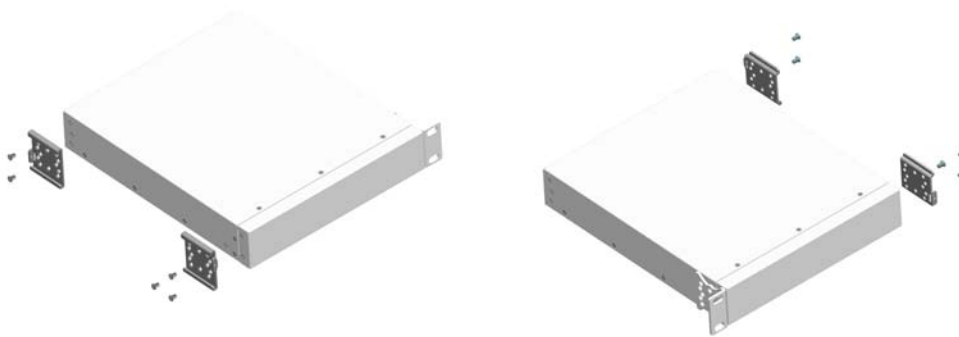

Attach Slot/Slide-Brackets

- 2 Align the chassis and slide both front and rear center brackets together.

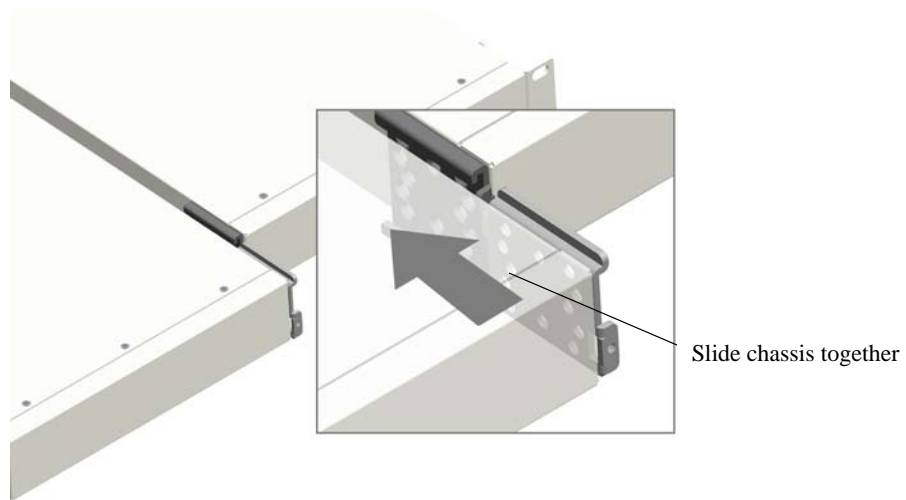

Slide Chassis Together

- 3 Place bracket plate over front and rear brackets and secure with thumb screws.

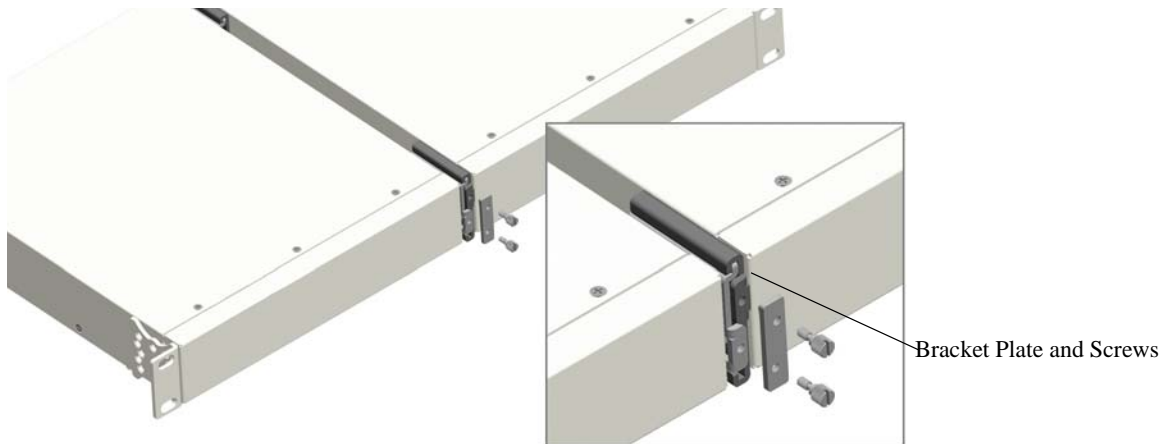

Secure Front and Back with Bracket Plate

Attaching Power Supply Tray to Rear of Chassis

To secure a power supply tray to the rear of the chassis, follow the steps below.

- 1 Insert the two tabs at the base of the tray into the slots provided at the bottom-rear portion of the switch chassis.

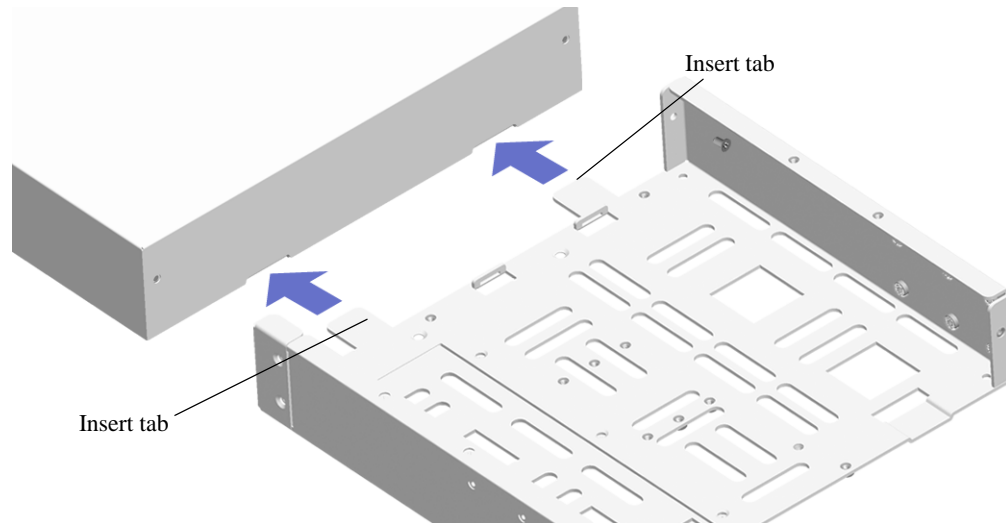

Insert Tabs Into Chassis Slots

- 2 Be sure that the two holes in the tray are aligned with the threaded holes in the rear panel of the chassis and secure the tray to the switch using the two attachment screws (M3 pan head).

Skip to [“Securing Power Supplies in Power Supply Tray” on page 4-13](#)

Securing Power Supplies in Power Supply Tray

Power Supply Brick Installation

- 1 Place the power supply into the power supply tray.

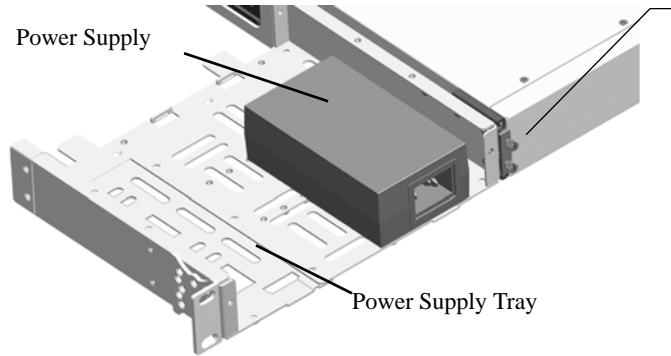

Place Power Supply Into Tray

- 2 Position the power supply bracket over the power supply ensuring the tabs are placed over the power supply holding it in place.

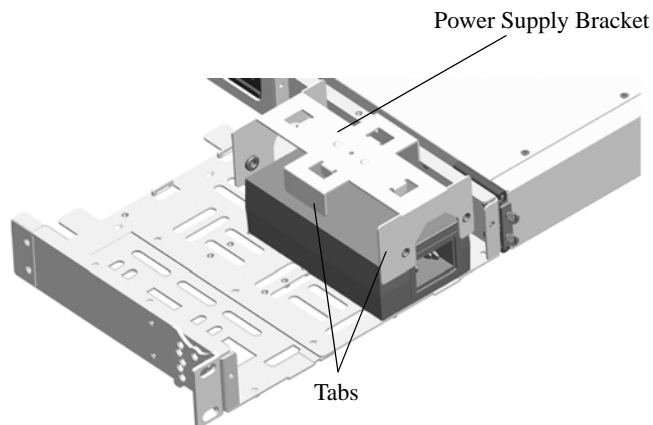

Power Supply Bracket

- 3 Secure the bracket and power supply using the retaining strap. Secure the retaining strap to the power supply tray using the attachment screws (provided).

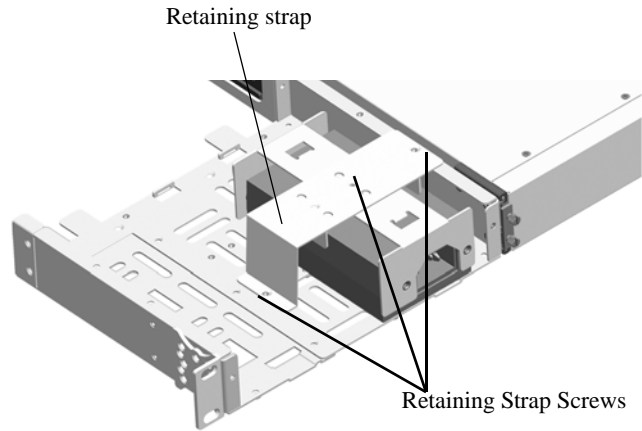

Secure Power Brick With Strap

Power Supply Module Installation

- 1 Place the power supply into the power supply tray.
- 2 Slide the power supply forward, aligning the guide posts with the holes in the chassis.
- 3 Firmly seat the power supply to the chassis and ensure the power supply tabs on the front bottom of the power supply slide into the slots on the power supply tray.

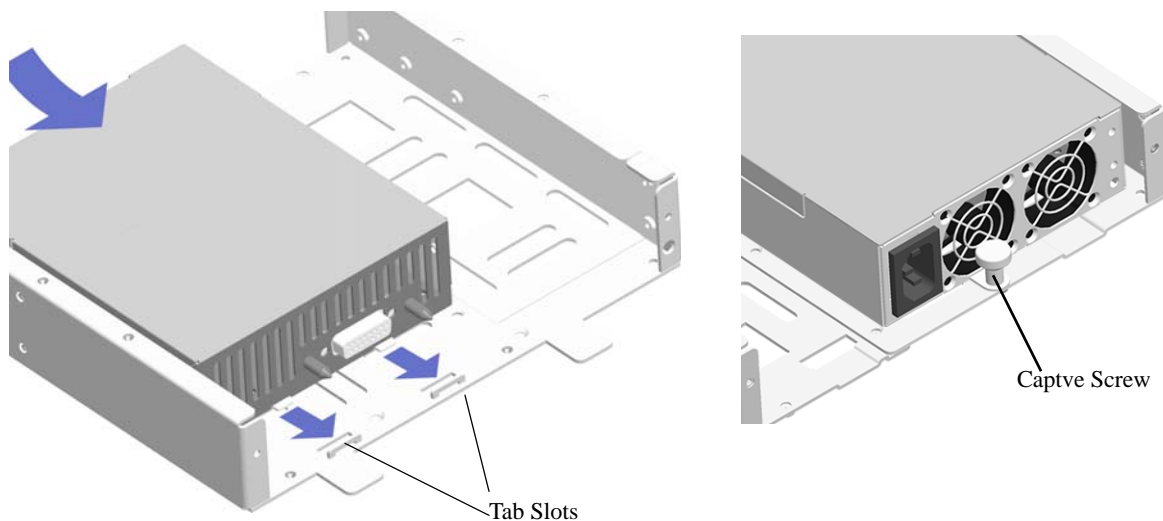

Securing Power Supply Module in Tray

- 4 Secure the power supply to the power supply tray using the captive thumb screw.

Mounting OS6250 Switches

Once the OS6250 is assembled it can now be mounted either in a rack, on a wall, or on a table.

Note. Only the OS6250-8M supports wall-mounting. (OS6250-WALL-MNT kit required).

Rack-Mounting OS6250 Switches

General Rack-Mounting Guidelines

If you will be rack-mounting your OS6250 switch(es), refer to the important guidelines below before installing.

- It is recommended that two people install the switch assembly on the rack—one person to hold the chassis and position it on the rack, and a second person to secure the chassis to the rack using attachment screws. (Please note that Alcatel-Lucent does not provide rack-mount screws. Use the screws supplied by the rack vendor.)
- To prevent a rack from becoming top heavy, it is recommended that you install heavier equipment at the bottom of the rack, whenever possible.
- Review [page 4-4](#) for recommended chassis clearances before installing.
- If you are installing the switch on a relay rack, be sure to install and secure the rack per the rack manufacturer's specifications.

Rack-Mounting Installation

- 1 Follow the proper assembly instructions based on the configuration of the chassis and power supply trays described in [“Assembling OS6250 Switches” on page 4-6](#).
- 2 Attach rack mount ears to both sides of the front of the chassis.

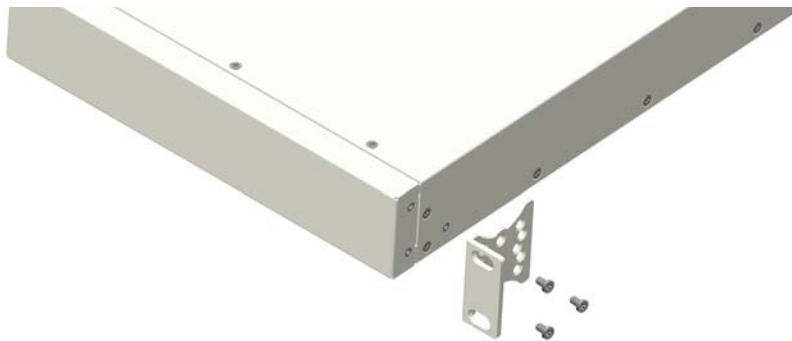

Attach Rack Mount Brackets

- 3 Using one additional person, lift and position the assembly on the rack until the rack-mount flanges are flush with the rack post.
- 4 Align the holes in the flanges with the rack holes.

- 5 Once the holes are aligned, insert a rack mount screw (not provided) through the *bottom hole of each flange*. Tighten both screws until they are secure.

When rack mounting, a clearance of 0.875 inches is recommended above the chassis.

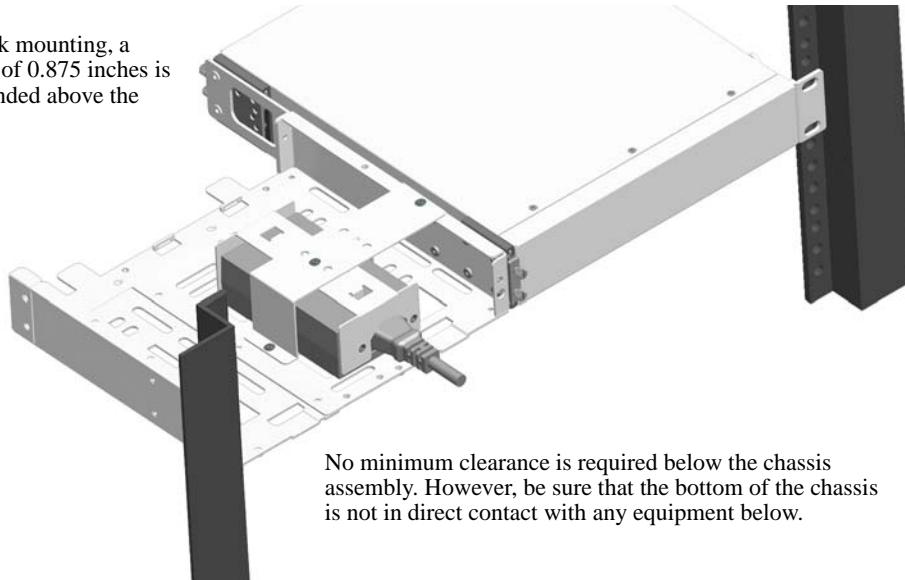

No minimum clearance is required below the chassis assembly. However, be sure that the bottom of the chassis is not in direct contact with any equipment below.

Rack-mounting Chassis with Power Supply Tray (OS6250-RM-19)

When rack mounting, a clearance of 0.875 inches is recommended above the chassis.

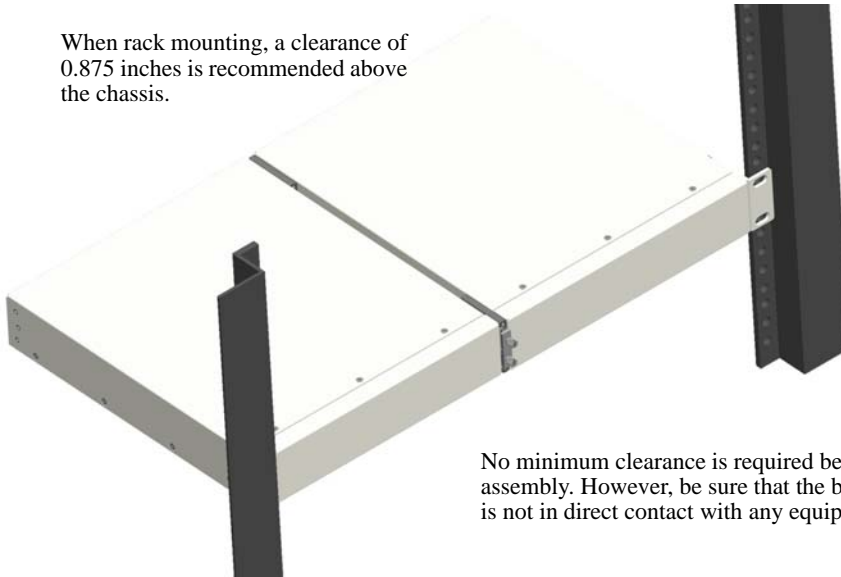

No minimum clearance is required below the chassis assembly. However, be sure that the bottom of the chassis is not in direct contact with any equipment below.

Rack-mounting Two Chassis (OS6250-DUAL-MNT)

Note. Be sure to install the screws in the *bottom hole* of each flange, as shown, before proceeding.

- 6 Once the screws at the bottom of each flange are secure, install the remaining two rack mount screws. Be sure that all screws are securely tightened.

Power Supply Tray - Removeable Section

When stacking multiple chassis, the power supply tray has a removeable section for providing access to the console and stacking ports.

- Remove the three top screws and the two side screws and slide removal section out.

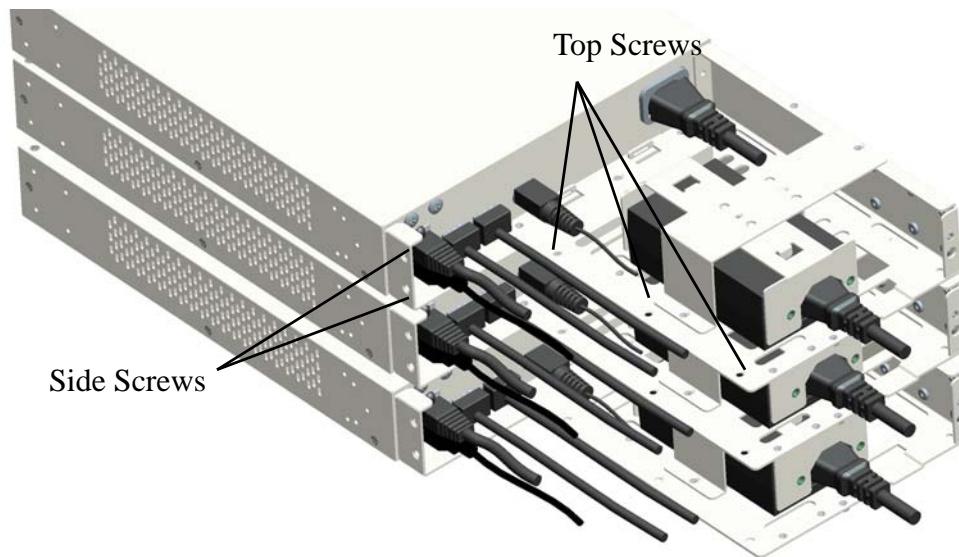

Stacked Chassis - Power Supply Tray Section Removed

OS6250-RM-19-L - Mounting Instructions

A single chassis can be mounted into a standard 19-inch rack as shown in the figure below..

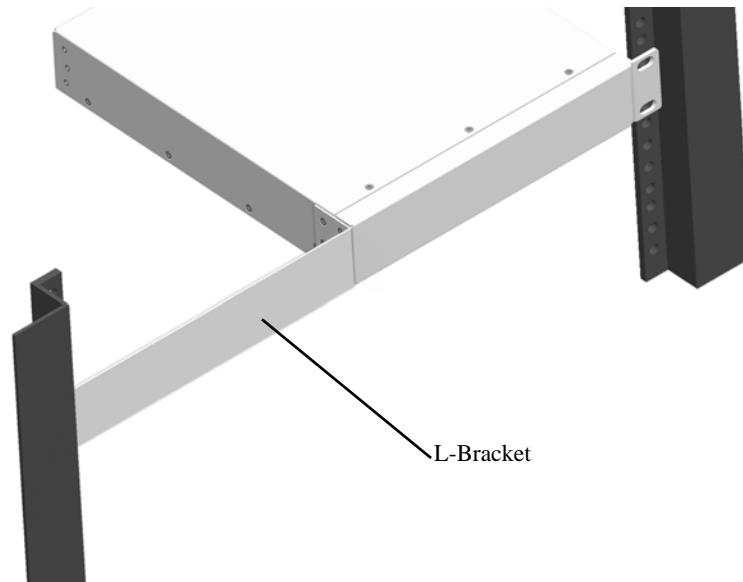

OS6250-RM-19-L

OS6250-REAR-MNT - Mounting Instructions

Alcatel-Lucent provides an optional rack mounting kit that allows OmniSwitches to be secured to both the front and back rails of the rack for additional stability.

Parts Provided

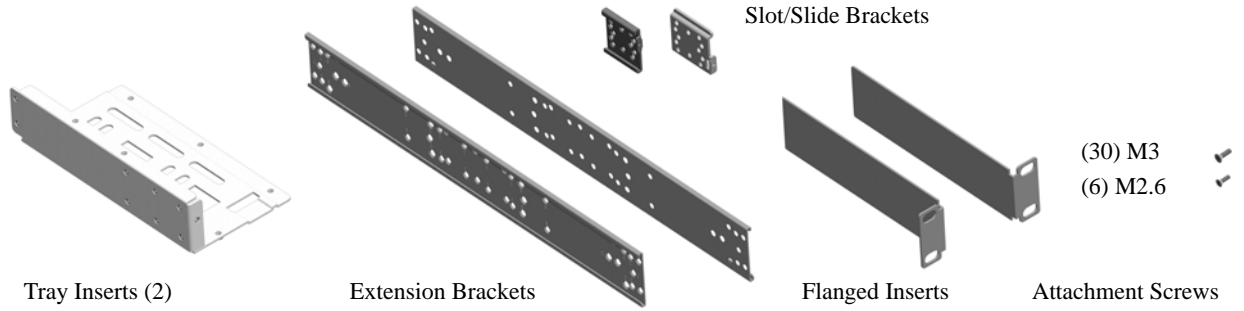

Steps

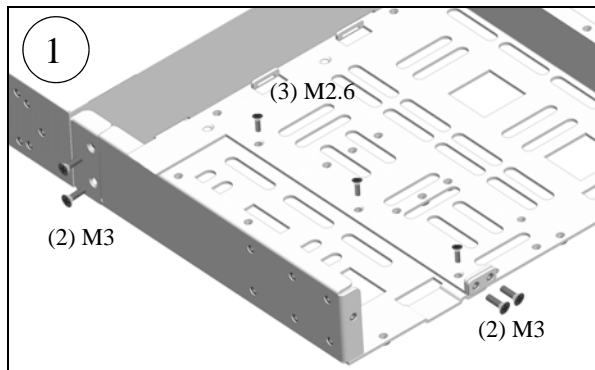

1. Attach the tray inserts to the power supply trays using the attachment screws, as shown.

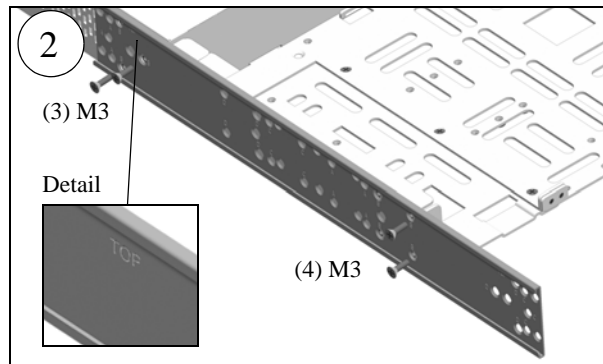

2. Attach an extension bracket to both sides of the chassis assembly. The guide rails should face out and the word “TOP” should face up. Be sure to use three screws at front and four at the rear of rails.

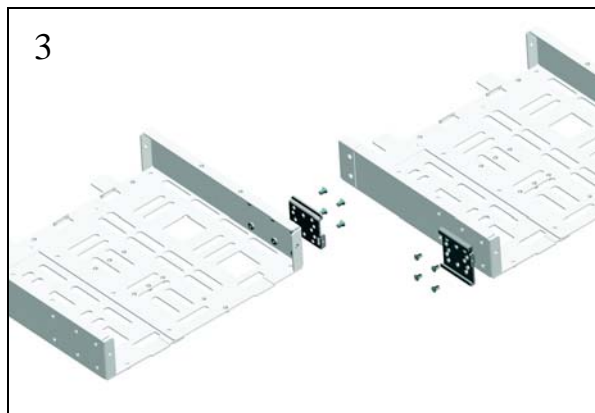

3. Attach the slide bracket to the rear of one power tray and the slot bracket to the rear of the other power supply tray and slide chassis together.

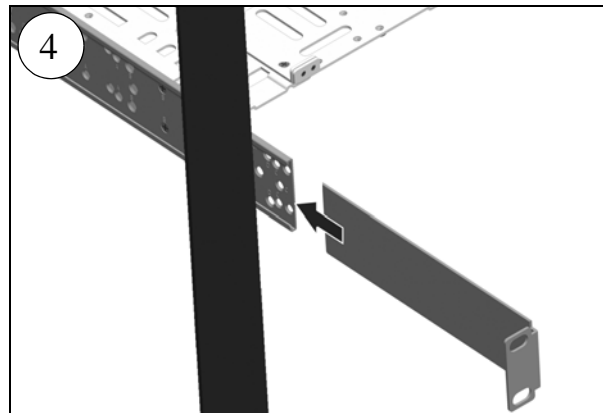

4. Slide the bracket inserts into the extension bracket guide rails until the flanges meet the rack. Be sure that the rack mount flanges are facing out and secure.

Completed Assembly

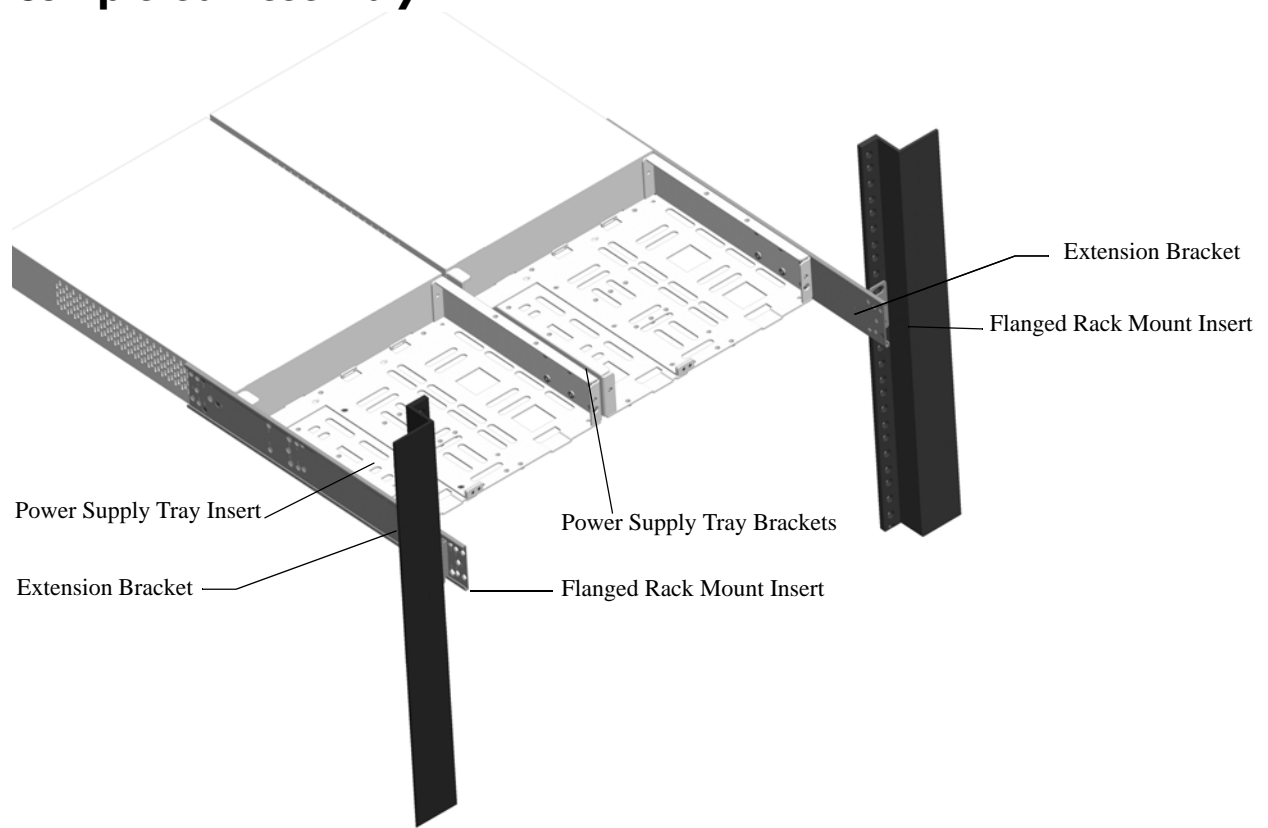

OS6250-REAR-MNT

Table-Mounting OS6250 Switches

General Table-Mounting Guidelines

OmniSwitch 6250 switches can be installed freestanding as tabletop-mounted units. If you will be table-mounting your switch(es), refer to the important guidelines below before installing.

- When choosing a location for the switch, be sure that adequate clearance has been provided for chassis airflow and access to the front, back, and sides of the chassis. For recommended clearances, refer to [“Recommended Clearances” on page 4-4](#).
- The power cord for OmniSwitch 6250 switches measures two (2) meters (approximately 6.5 feet) in length. When table mounting the switch, be sure that the mounting location is within the reach of all the required power sources.
- An additional mounting kit is needed to table-mount the chassis.

Table-Mounting Installation

- 1 Follow the proper assembly instructions based on the configuration of the chassis and power supply trays described in [“Assembling OS6250 Switches” on page 4-6](#).
- 2 Orient the table-mount brackets so that the rubber bumpers are facing down. Attach the brackets to both sides of the switch, as shown.

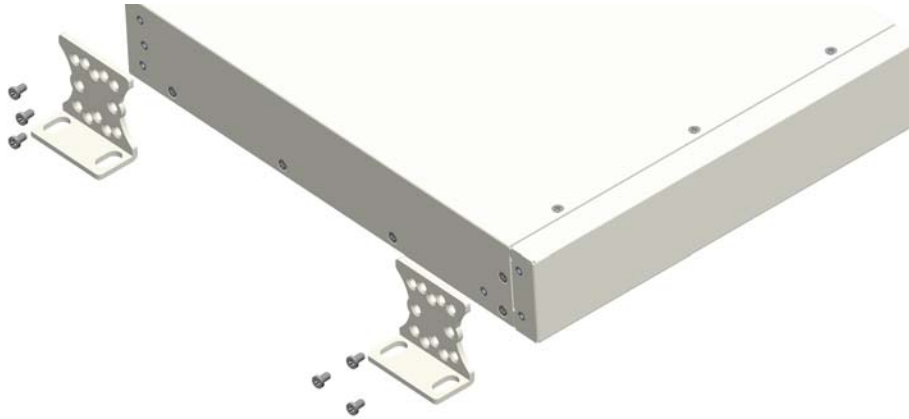

Bracket Orientation for Table Mounting

- 3 Attach the additional mounting brackets to the rear portion of the power supply tray that was installed at step 1 (again, so that the rubber bumpers are facing down). Attach the brackets to both the left and right side of the tray.

4 If preferred, mount the complete switch assembly to the table by inserting attachment screws (not provided) through the flat portion of the mounting brackets and into the mounting surface. Do not over-tighten. Otherwise, the switch/power supply tray assembly may simply be placed on the table surface without attachment screws.

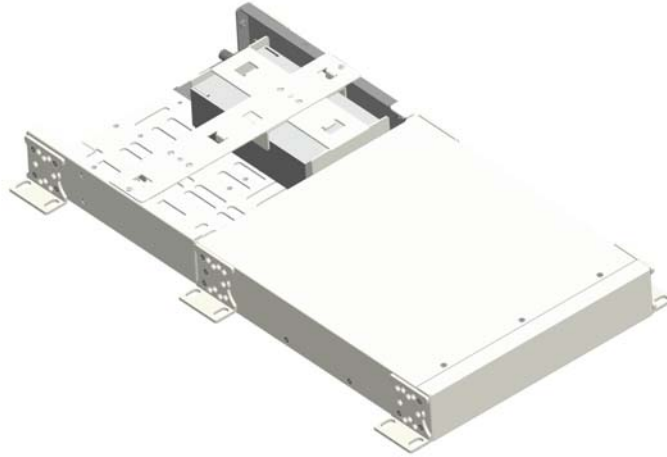

Table Mounted Chassis

Wall-Mounting the OS6250-8M

The OmniSwitch OS6250-8M switch can also be installed as a wall-mounted unit.

Note. Only the OS6250-8M supports wall-mounting. (OS6250-WALL-MNT kit required).

General Wall-Mounting Guidelines

- When choosing a location for the switch, be sure that adequate clearance has been provided for chassis airflow and access to the front, back, and sides of the chassis. For recommended clearances, refer to [“Recommended Clearances” on page 4-4](#).
- For wall mounting, it is recommended that the chassis assembly is oriented sideways, with the chassis front panel facing left, as shown in the diagram below.
- In order to ensure that damage to the power cord does not occur, steps must be taken to provide proper routing of the power cord, as well as proper access to the switch’s power source (i.e., grounded outlet). Refer to the guidelines listed below for additional details.
- The power cord for OmniSwitch 6250 switches measures two (2) meters (approximately 6.5 feet) in length. When wall mounting the switch, be sure that the mounting location is within the reach of all the required power sources. In addition, the power cord must not be attached to the building surface (e.g., with U-brackets, cord retainer clips, or other fasteners), nor run through walls, ceiling, floors and similar openings in the building structure.
- Be sure that the wall section and wall attachment screws (not provided) have the required strength to easily support the chassis assembly. A complete OS6250 chassis assembly—with mounting brackets, power supply tray, and redundant power supplies—weighs approximately 12 lbs.
- For each mounting hole the use of screws long enough to penetrate any soft surfaces, such as sheet-rock or drywall, and securely attach to a hard surface such as a wall stud is recommended.
- Two people will be required to wall mount the switch: one person to hold the chassis assembly in place and one person to mark the locations for the mounting screws.
- An additional mounting kit is needed for wall-mounting the chassis.

OS6250-WALL-MNT - Wall-Mounting Installation

- 1 Follow the proper assembly instructions based on the configuration of the chassis and power supply trays described in [“Assembling OS6250 Switches” on page 4-6](#).
- 2 Orient the wall-mount brackets so that the rubber bumpers are facing down. Attach the brackets to both the left and right side of the switch, as shown.

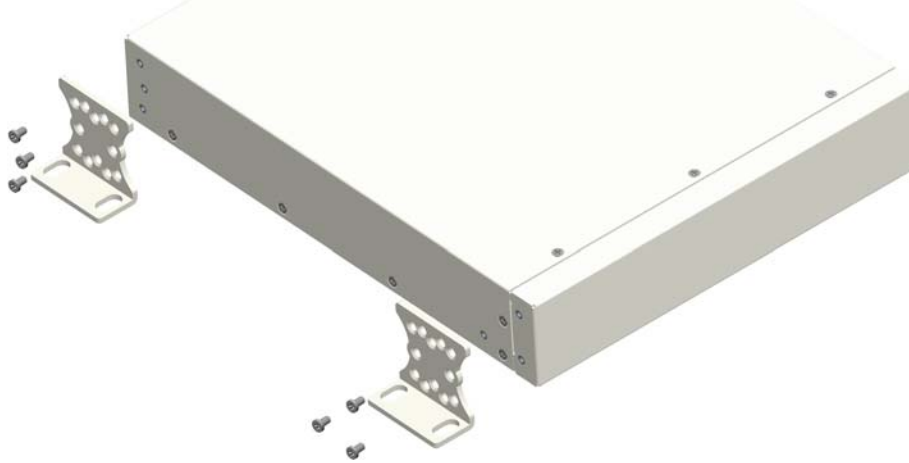

Attaching the wall-mount brackets.

- 3 Attach two additional mounting brackets to the rear portion of the chassis so that the rubber bumpers are facing down. Attach the brackets to both the left and right side of the switch.
- 4 Use one person to securely hold the chassis assembly in position on the wall. Mark the location of the holes in the mounting brackets on the wall.
- 5 Pre-drill the wall (if required).

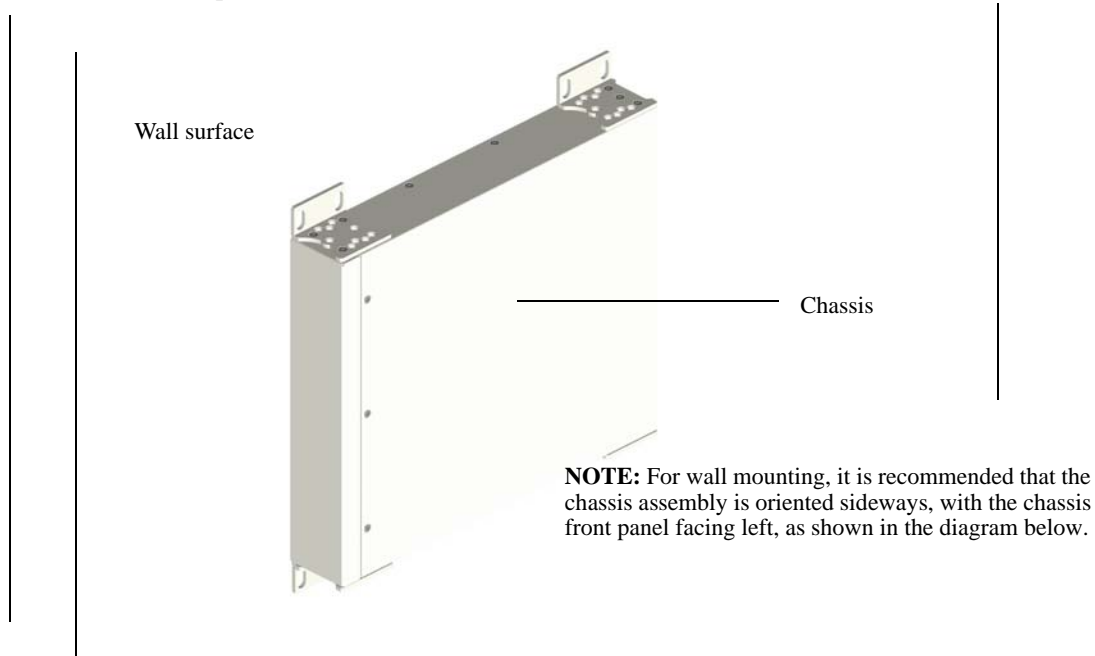

Recommended Wall Mount Chassis Orientation (OS6250-WALL-MNT)

Note. Wall fasteners are not provided with your switch and will vary depending on the type of wall surface. Be sure to use fasteners that are approved for the full weight of the chassis assembly. Consult fastener specifications for full details.

- 6 Secure the unit to the wall using appropriate wall fasteners.

Connecting Chassis to Power Source

AC Power Supply Connections

Since the power cord is the switch's only disconnect device, it should be plugged into an easily accessible outlet. In the event that your power cord is lost or damaged, refer to the specifications below.

Powering On a Chassis

Follow the steps below to power on the chassis using an AC power source:

- 1 Connect the IEC-60320-C15 end of the supplied power cord to the primary and optional redundant power supply.
- 2 Install the cord retainer bracket to the back of each installed power supply bracket using the attachment screws (provided). Place the slotted retainer clip over the bracket with the retainer fingers pointing down and slide the retainer bracket toward the power supply until it meets the power cord connector. Insert two screws (provided) into the retainer clip slots and tighten until secure.

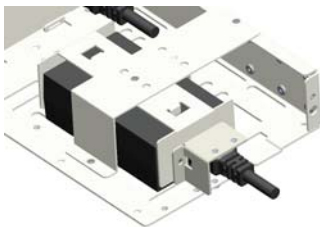

Retainer bracket

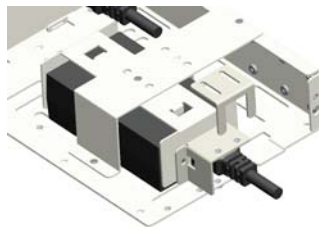

Slotted retainer clip

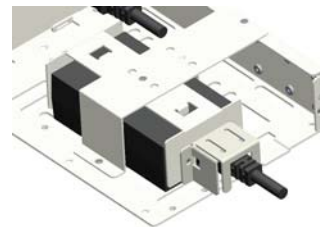

Secured Power Cord

- 3 Connect primary and optional redundant power supplies to AC power source.
- 4 Monitor the chassis as it boots.

OS6250-24MD Internal DC Power Supply Connections

The internal DC power supply has the following additional considerations. Refer to the installation steps described in [“OS6250-24MD Internal DC Power Supply Connections” on page 4-27](#)

- Connect to a -48V or -60V reliably grounded DC SELV source.
- Use common DC return connections for the DC power supplies. The DC return terminal conductor should be connected to the equipment frame.
- The Branch Circuit Overcurrent Protection must be rated a Maximum of 15A.
- Use 12AWG solid copper conductors only.
- A readily accessible disconnect device that is suitably approved and rated shall be incorporated in the field wiring.

Backup DC Power Brick Connections

The backup DC power brick has the following additional considerations. Refer to the installation steps described in [“OS6250-24MD Internal DC Power Supply Connections” on page 4-27](#)

- Connect to a -48V or -60V reliably grounded DC SELV source.
- Use common DC return connections for the DC power supplies. The DC return terminal conductor should be connected to the equipment frame.
- The Branch Circuit Overcurrent Protection must be rated a Maximum of 5A.
- Use 22AWG solid copper conductors only.
- A readily accessible disconnect device that is suitably approved and rated shall be incorporated in the field wiring.

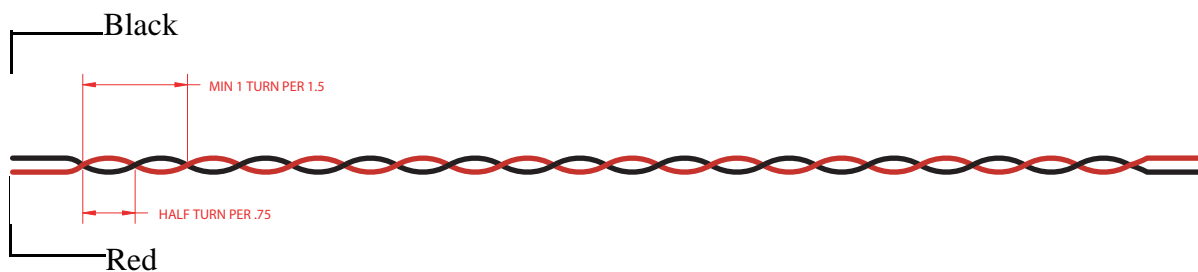

Twisted pair wire (red and black) for a DC power supply

Note. Refer to the wiring diagram for information on connecting the DC power supply to a DC power source.

Securing the Redundant DC Power Supply Connector

If a redundant DC power supply is to be used, follow the steps below to securely mount the redundant DC power connector to the power supply tray.

- 1 Secure the DC power connector bracket to the power supply tray using the screws provided.

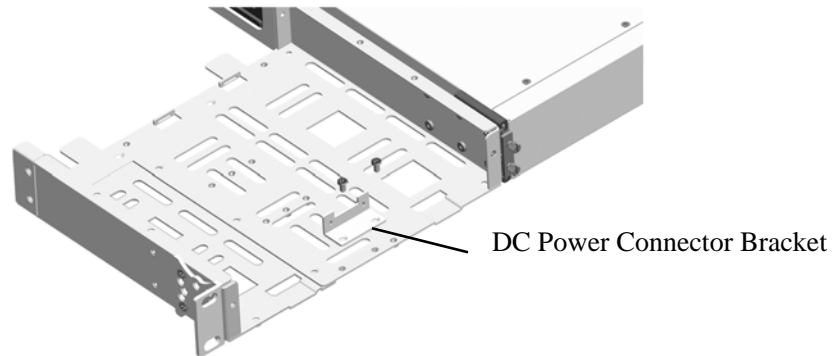

Secure DC Power Connector Bracket

- 2 Slide the female DC power connector into the bracket and secure to the bracket with the screws provided.
- 3 Connect the male DC connector to the female connector and secure to the female DC connector with the captive screws contained in the male DC connector.

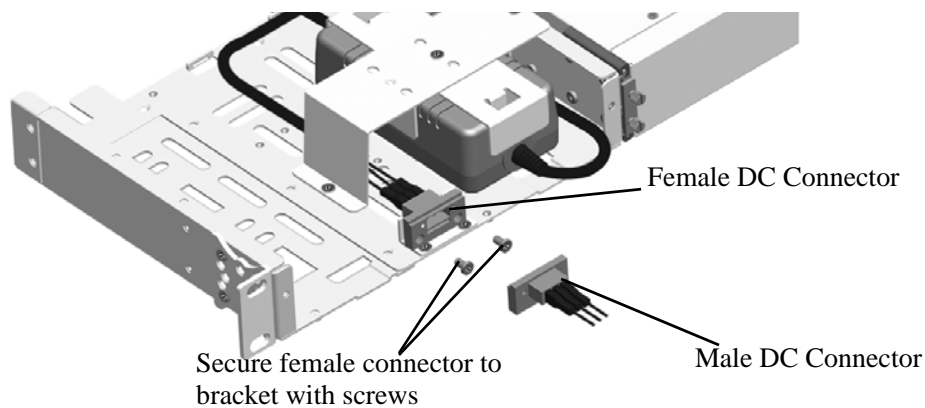

Secure DC Power Connector Bracket

Installing DC Power Source Wire Leads

The DC power supply on your switch contains a power connector with three (3) square slots for connecting the positive, negative, and ground wires from a DC power source.

DC Power Connectors

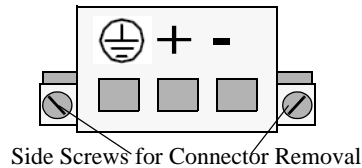

OmniSwitch DC Power Supply Connector

A clamp inside each slot keeps the power wire tightly in place during operation. The DC power supply has side screws that can be used to remove the connector if required.

These instructions describe how to connect your 3-wire DC power source to the power connector on your DC power supply. A small flat-tip screwdriver and a wire stripper are required for this procedure.

- 1 Prepare the three (3) wires—12 gauge—that will plug into the power supply. First make sure they are not plugged into the DC power source. Next, use a wire stripper to carefully strip between .24 and .30 inches (6-7.5 mm) off the end of each wire, removing the outer insulation to expose the copper core.
- 2 Open the clamp for the ground wire slot by inserting a small flat-tip screwdriver into the top of the appropriate circular hole. Loosen the screw so that the clamp for the ground wire opens.

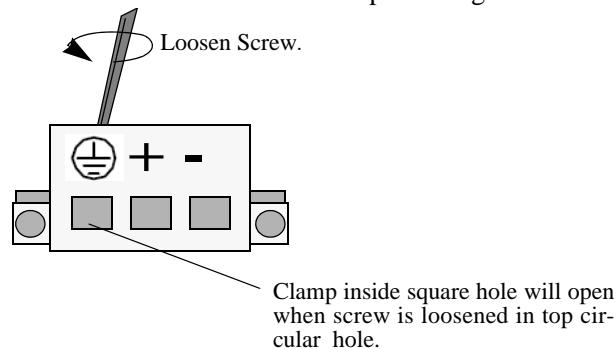

Opening Connector for Ground Wire

- 3 Insert the ground wire lead into the slot. The lead you insert *must* match the lead attached to the DC power source.

Warning. You must plug DC wire leads into the correct holes in the DC power connector. Use the labels above the DC power connector as a guide to positive, negative, and ground connections. If the wire leads are plugged into the wrong holes, the power supply will not work properly and damage to the unit may result.

Push the wire in far enough such that it reaches the back wall of the connector, about a half inch inside.

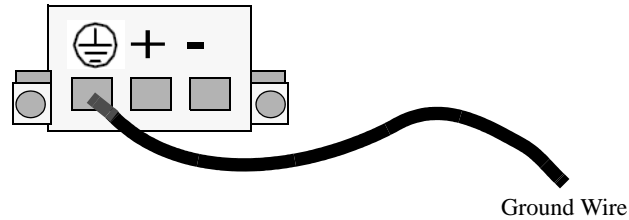

Attaching the Ground Wire

4 Tighten the clamp by tightening the screw above the slot into which you inserted the wire lead. The wire lead should be securely attached inside the connector. You should be able to pull on the wire and not dislodge it.

Warning. For both 48V and -60V input voltages, the positive (+) wire of the sourcing equipment, such as a battery or rectifier, must be connected to the positive (+) terminal of the OmniSwitch DC power supply and the negative (-) wire of the sourcing equipment must be connected to the negative (-) terminal of the OmniSwitch DC power supply. This rule always applies to both 48V, and -60V input voltages, regardless of the polarity signs shown on the power supply specification labels such as: -48V, +48V, or -60V.

5 Repeat Steps 2 through 4 for the remaining positive and negative wire leads.

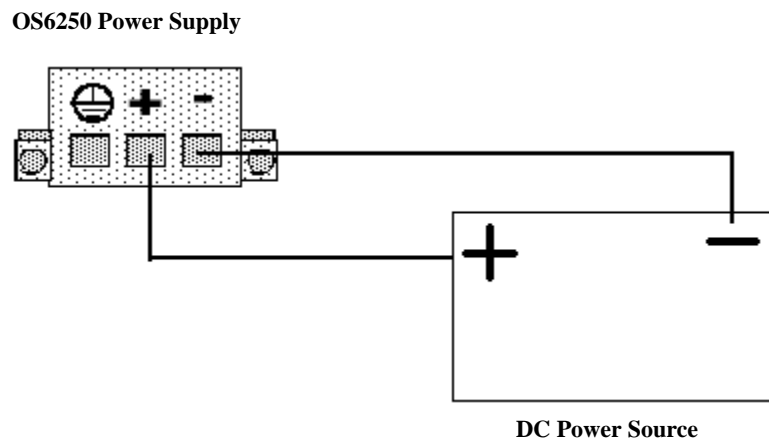

Correct Polarity Connections

Hot-Swapping Power Supplies

Hot swapping is supported on models with redundant power supplies. In order to support the hot swapping of power supplies, the switch must have:

- An operational redundant power supply

Note. Hot swapping power supplies on switches without redundant system power will result in system power interruption and a loss of network connectivity.

To hot swap power supplies, follow the steps below:

- 1** Begin by locating the power supply to be swapped, then disconnect the power cord from its power source. The system will remain operational.
- 2** Remove the two screws located at the top of the power cord retainer bracket. Set the retainer clip and screws aside; they will need to be reinstalled later.
- 3** Unplug the power cord from the power supply.
- 4** Next, remove the attachment screws used to secure the power supply retaining strap to the power supply tray. Set the screws aside; they will need to be reinstalled later.
- 5** Carefully remove the retaining strap from the power supply tray. Be careful not to disrupt the operational power supply adjacent to the power supply being hot swapped.
- 6** Lift the power supply that is being hot swapped out of the power supply tray and unplug its connector cable from the power supply port located in the back of the switch chassis.
- 7** Install the new power supply by following the installation steps beginning at step 3 on [page 4-13](#) of this chapter.

5 Booting 6250 Switches

For information on booting stand-alone switches and switches in stacked configurations, refer to the sections below.

Booting an OmniSwitch 6250

The OmniSwitch 6250 switch does not use an on/off switch. The power cord is the switch's only connect/disconnect device. The power connector socket is located on the power supply rear panel. For more information, refer to [“OmniSwitch 6250 Chassis and Hardware Components” on page 3-1](#).

To boot the switch, plug the power cord into an easily-accessible power source, such as a grounded AC outlet or an Uninterruptible Power Supply (UPS).

The switch immediately begins the boot process. Allow a few moments for the switch to boot completely, then verify the status of all LEDs on the switch's front panel. A successful boot displays the following LED states:

LED States for a Stand-Alone Switch

OK	Solid green
PRI	Solid green
STK	Amber
PWR	Solid Green
BPS	Solid green or OFF if no backup power supply is connected.

LED States for a Stacked Switch

OK	Solid green
PRI	Solid green (primary); Amber (Secondary); Off (Idle)
STK	Green
PWR	Solid Green
BPS	Solid green or OFF if no backup power supply is connected.

If any of the LED state differs from the states shown in the table above, refer to [page 3-7](#) for more information. Contact Alcatel-Lucent Customer Support if the LED state persists.

For information on logging in and configuring your OmniSwitch 6250 switch, refer to the *OmniSwitch Getting Started Guide*.

Console Port

The console port, located on the chassis front panel, provides a console connection to the switch and is required when logging into the switch for the first time. By default, this RJ-45 connector provides a DTE console connection.

Serial Connection Default Settings

The factory default settings for the serial connection are as follows:

baud rate	9600
parity	none
data bits (word size)	8
stop bits	1
flow control	none

Modifying the Serial Connection Settings

The switch's serial connection defaults are listed above. If you wish to modify the default serial connection settings (i.e., baud rate, parity, data bits, and stop bits), refer to the following steps:

Note. You must be connected to the switch via the console port before attempting to change serial connection settings. Otherwise, an error message will display.

For switches in a stacked configuration, all changes must be configured before the switches are cabled together. In other words, you must configure these settings when each switch is operating as a stand-alone unit.

-
- 1 Enter the **modify boot parameters** command at the CLI prompt. The boot prompt displays:

```
Boot >
```

- 2 To change the baud rate, enter **boot serialbaudrate**, followed by the desired baud rate value. Options include 1200, 2400, 4800, 9600 (default), 19200, 38400, 57600, 76800, and 115200. For example:

```
Boot > boot serialbaudrate 19200
```

Note. Setting the console port to speeds above 9600 baud can cause problems with Zmodem uploads.

- 3 To change the parity value, enter **boot serialparity**, followed by the desired parity value. Options include none (default), even, and odd. For example:

```
Boot > boot serialparity even
```

- 4 To change the data bits (i.e., word size) value, enter **boot serialwordsize**, followed by the number of data bits. Options include 7 and 8 (default). For example:

```
Boot > boot serialwordsize 7
```

- 5 To change the stop bits value, enter **boot serialstopbits**, followed by the number of stop bits. Options include 1 (default) and 2. For example:

```
Boot > boot serialstopbits 2
```

- 6 Verify your current changes by entering **show** at the boot prompt:

```
Boot > show
Edit buffer contents:
Serial (console) baud      : 19200
Serial (console) parity   : even
Serial (console) stopbits : 2
Serial (console) wordsize : 7
```

(additional table output not shown)

- 7 You can save your changes to the **boot.params** file by entering **commit file** at the boot prompt:

```
Boot > commit file
```

When the **commit file** command is used, changes will not be enabled until after the next switch reboot.

- 8 You can also save your changes in real time to the switch's running memory by entering **commit system** at the boot prompt:

```
Boot > commit system
```

Caution. There are two important things to consider when using the **commit system** command to save serial connection changes:

- Output to the terminal may become illegible due to incompatible serial connection settings between the switch and the terminal emulation software.
- If you use the **commit system** command only, changes will *not* be saved to the switch's **boot.params** file and will be lost if the switch is rebooted. To save changes to the **boot.params** file, refer to step 7.

-
- 9 Return to the CLI prompt by entering **exit** at the boot prompt.

Viewing the Power Supply Status

The switch constantly monitors the power supply operation. If either the primary or backup power source (optional) unexpectedly shuts down, the switch sends out a notification to the user. In addition, the power LED on the chassis front panel displays solid amber.

Note. For detailed OmniSwitch 6250 LED information, refer to [“LED Status” on page 3-20](#).

To check the number of power supplies currently operating, and the status of each power supply, use the **show power** command. For example:

```
-> show power

Power Supplies in chassis 1
PS          Operational Status
-----+-----
PS-1        UP
PS-2        NOT PRESENT
```

The primary (i.e., factory-installed) power supply is listed as **PS-1** in the **show power** command output. The backup power supply is listed as **PS-2**. In the example above, there is no backup power supply installed.

Monitoring the Chassis

OmniSwitch 6250 switches can be monitored and managed via the console port using Command Line Interface (CLI) commands. The switches can also be monitored and managed via the Ethernet using CLI commands, WebView, SNMP, and OmniVista.

The section below provides some examples of useful hardware-related monitoring CLI commands. Refer to the *OmniSwitch CLI Reference Guide* for detailed information on all management and monitoring commands used with the OmniSwitch 6250 switch.

Checking the Overall Chassis Status

To check the overall status of a chassis, including the chassis type, and current administrative and operational status, use the **show chassis** command. For example:

```
-> show chassis
```

```
Chassis 1
  Model Name:          OS6250-14,
  Description:         12 RJ45 + 2 SFP,
  Part Number:         902632-90,
  Hardware Revision:   B07,
  Serial Number:       H47Q0027,
  Manufacture Date:    JAN 03 2008,
  Admin Status:        POWER ON,
  Operational Status:  UP,
  Number Of Resets:    23
  MAC Address:         00:e0:b1:6b:ef:30,
```

For a complete list of output definitions for this command, refer to the *OmniSwitch CLI Reference Guide*.

Checking the Temperature Status

To check chassis temperature status, including the current temperature and configured threshold values, use the **show temperature** command. For example:

```
-> show temperature
```

```
Temperature for sensor 1
  Hardware Board Temperature (deg C)           = 39,
  Temperature Upper Threshold Range (deg C)    = 14 to 86,
  Temperature Upper Threshold (deg C)         = 80,
  Temperature Status                           = UNDER THRESHOLD,
  Temperature Danger Threshold (deg C)        = 86
```

For a complete list of output definitions for this command, refer to the *OmniSwitch CLI Reference Guide*.

Checking the Fan Status

To check the current status for all six fans in the chassis, use the [show fan](#) command. For example:

```
-> show fan
Chassis Fan  Status
-----+-----
      1      1  Running
      1      2  Running
      1      3  Running
      1      4  Running
```

For a complete list of output definitions for this command, refer to the *OmniSwitch CLI Reference Guide*.

Checking the Power Supply Status

For information on checking power supplies for OmniSwitch 6250 switches, refer to “[Booting 6250 Switches](#)” on page 5-1.

Additional Monitoring Commands

CLI Commands Used for Monitoring a Chassis

show cmm	Displays the basic hardware and status information for primary and secondary management modules (if applicable).
show ni	Displays the basic hardware and status information for individual modules. If the switch is a standalone, information for the stand alone switch displays.
show module	Displays the basic information for individual modules. If the switch is a standalone, information for the stand-alone switch displays.
show module long	Displays the detailed information for individual modules. If the switch is a standalone, information for the standalone switch displays.
show module status	Displays the basic status information for individual modules. If the switch is a standalone, information for the standalone switch displays.

Using LEDs to Visually Monitor the Chassis

The front and rear panel of OmniSwitch 6250 switches provides status LEDs that are useful in visually monitoring the status of the switches. LEDs include:

- Ethernet Port LEDs
- System Status LEDs
- Combo Port Status LEDs

For tables showing LED states operating normally, refer to [“LED Status” on page 3-20](#).

Installing SFP and XFP Transceivers

For information on installing XFPs and SFPs, refer to the *OmniSwitch Transceivers Guide*.

6 Managing Power over Ethernet (PoE)

Power over Ethernet (PoE) is supported on OmniSwitch 6250 switches and provides inline power directly from the switch's Ethernet ports. Powered Devices (PDs) such as IP phones and wireless APs can be powered directly from the switch's RJ-45 ports.

As the feature reduces devices' dependence on conventional power sources, PoE eliminates many restrictions that traditional electrical considerations have imposed on networks.

In a PoE configuration, Power Source Equipment (PSE) detects the presence of a PD and provides an electrical current that is conducted along the data cable. The PD operates using the power received via the Ethernet data cable; no connection to an additional power source (e.g., an AC wall socket) is required.

Note on Terminology. There are several general terms used to describe the feature, PoE. The terms *Power over Ethernet (PoE)*, *Power over LAN (PoL)*, *Power on LAN (PoL)*, and *Inline Power* are synonymous terms used to describe the powering of attached devices via Ethernet. For consistency, this chapter and the *CLI Command Reference Guide* refer to the feature as *Power over Ethernet (PoE)*.

Additional terms, such as *Powered Device (PD)* and *Power Source Equipment (PSE)* are not synonymous with PoE, but are directly related to the feature:

- *PD* refers to any attached device that uses a PoE data cable as its only source of power. Examples include access points, such as IP telephones, Ethernet hubs, wireless LAN stations, etc.
- *PSE* refers to power sourcing equipment, which provides power to a single link section. PSE main functions include searching the PD, optionally classifying the PD, supplying power to the link section only if the PD is detected, monitoring the power on the link section, and scaling power back to detect level when power is no longer requested or required.

As the OmniSwitch 6250 switches fully support Ethernet connectivity, you may also attach non-PD equipment, such as computer workstations, printers, servers, etc. to PoE ports. See [Chapter 3, "OmniSwitch 6250 Chassis and Hardware Components,"](#) for more information on the OmniSwitch 6250 chassis.

Important. Alcatel-Lucent recommends that PoE-enabled switches with attached IP telephones should have operational power supply redundancy at all times for 911 emergency requirements. In addition, both the switch and the power supply should be plugged into an Uninterruptible Power Source (UPS).

In This Chapter

This chapter provides specifications and descriptions of hardware and software used to provide PoE for attached devices.

The chapter also provides information on configuring PoE settings on the switch through the Command Line Interface (CLI). CLI commands are used in the configuration examples; for more details about the syntax of commands, see the *OmniSwitch CLI Reference Guide*. Topics and configuration procedures described in this chapter include:

- Power over Ethernet Specifications on [page 6-3](#)
- Viewing Power Status on [page 6-4](#)
- Configuring Power over Ethernet Parameters on [page 6-5](#)
- Understanding Priority Disconnect on [page 6-8](#)
- Monitoring Power over Ethernet via the CLI on [page 6-11](#)

Note. You can also monitor all chassis components and manage many chassis features, including Power over Ethernet, with WebView, Alcatel-Lucent's embedded web-based device management application. WebView is an interactive and easy-to-use GUI that can be launched from the OmniVista or a web browser. Please refer to *WebView's Online Documentation* for more information.

Power over Ethernet Specifications

The table below lists general specifications for Alcatel-Lucent's Power over Ethernet support. For more detailed power supply and Power Source Equipment (PSE) specifications, refer to [Chapter 3, "OmniSwitch 6250 Chassis and Hardware Components."](#)

IEEE Standards supported	IEEE 802.3af; 802.3at
Default PoE administrative status	Enabled
Default PoE operational status	Disabled (PoE must be activated on a switch-by-switch basis via the lanpower start command.)
Platforms supporting PoE	OmniSwitch 6250-P24
Cable distances supported	100 meters (approx.)
Total number of PoE-capable ports per switch	24
Default amount of inline power available (1-6, 23/24 or 25/26)	31000 milliwatts
Default amount of inline power available (7-22)	16000 milliwatts
Range of inline power allowed (1-6, 23-24 or 25-26)	3000 - 31000 milliwatts
Range of inline power allowed (7-22)	3000 - 16000 milliwatts
PoE Power Supply	225 Watts

Note. Ports pairs 23/24 and 25/26 cannot have PoE enabled at the same time. By default, ports 23/24 have PoE capability enabled and ports 25/26 have PoE capability disabled. See ["Enabling/Disabling PoE on Copper Combo Ports"](#) on page 6-6 for information on enabling PoE on the copper combo ports.

Viewing PoE Power Supply Status

To view the current status of power supplies installed, use the **show power** command, as shown below:

```
-> show power
Slot  PS    Wattage  Type   Status  Location
-----+-----+-----+-----+-----+-----
  1    1      225     AC    UP      External
  1    2      225     AC    UP      External
  2    1      225     AC    UP      External
  2    2      225     AC    UP      External
```

For detailed information on the **show power** command output, refer to the *CLI Command Reference Guide*.

Configuring Power over Ethernet Parameters

Power over Ethernet Defaults

The following table lists the defaults for PoE configuration:

Parameter Description	Command(s)	Default Value/Comments
PoE operational status	lanpower start or lanpower stop	Disabled
Total power available to a port	lanpower power	16 Watts (802.3af) 31 Watts (802.3at)
Total PoE power available to an entire chassis	lanpower maxpower	225 Watts
Power priority level for a port	lanpower priority	low
Priority disconnect status	lanpower priority-disconnect	Enabled

Understanding and Modifying the Default Settings

The sections below provide information on each of the key components within the Power over Ethernet software. They include information on PoE-related CLI commands. For detailed information on PoE-related commands, refer to the *OmniSwitch CLI Reference Guide*.

Setting the PoE Operational Status

Enabling PoE

By default, Power over Ethernet is *administratively enabled* in the switch's system software. However, in order to physically activate PoE, you must issue the **lanpower start** command on a slot-by-slot basis before any connected PDs will receive inline power.

To activate power to PoE-capable in a switch, enter the corresponding slot number only. For example:

```
-> lanpower start 1
```

If power to a particular port has been disconnected via the **lanpower stop** command, you can reactivate power to the port by specifying both the *slot* and *port* in the command line. For example:

```
-> lanpower start 1/1
```

Note. You cannot use the *slot/port* syntax to initially activate PoE on a port. This syntax is intended only to reactivate power to those that have been disconnected via the **lanpower stop** command. To initially activate PoE, you must use the **lanpower start slot** syntax only, as described above.

Disabling PoE

To disable PoE on a particular slot or port, use the **lanpower stop** command.

To disable PoE on a *specific PoE-capable port*, enter a *slot/port* number. For example:

```
-> lanpower stop 1/4
```

To disable PoE for *all PoE-capable in a slot*, enter the corresponding slot number only. For example:

```
-> lanpower stop 1
```

Enabling/Disabling PoE on Copper Combo Ports

To enable the PoE capability on the copper combo ports use the **lanpower combo-port** command, for example:

```
-> lanpower 1 combo-port enable
```

Enabling PoE capability on the copper combo ports disables PoE capability on ports 23/24 and vice versa

Configuring the Total Power Available to a Port

By default, each port is authorized by the system software to use up to a maximum amount of milliwatts to power any attached device.

You can either increase or decrease this value based on the range in the specifications table.

Increasing the total power available to an individual port may provide a more demanding Powered Device (PD) with additional power required for operation. Decreasing the total power available to a port helps to preserve inline power and assists in the overall management of the switch's power budget.

To increase or decrease the total power available to an individual port, use the **lanpower power** command. Since you are setting the power allowance for an individual port, you must specify a *slot/port* number in the command line. For example, the syntax

```
-> lanpower 1/1 power 3000
```

reduces the power available on port 1 of the switch to 3000 milliwatts. This new value is now the maximum amount of power the port can use to power any attached device (until the value is modified by the user).

Configuring the Total Power Available to a Switch

Like the maximum port power allowance, the system software also provides a maximum *slot-wide* power allowance. By default, each switch is authorized by the system software to use up to the maximum watts available from the PoE power supply.

As with the maximum port power allowance, the user can either increase or decrease this value based on the range in the specifications table.

Increasing the total power available to a switch may provide more demanding Powered Devices (PDs) with additional power required for operation. Decreasing the total power available helps preserve inline power and assists in the overall management of the switch's power budget.

Important. Before changing the maximum slot-wide power allowance, you must disable PoE for the slot via the **lanpower stop** command. Once the new value is assigned, re-enable PoE for the slot via the **lanpower start** command.

To increase or decrease the total power available to a slot, use the **lanpower maxpower** command. Since you are setting the power allowance for an individual slot, you must specify a *slot* number in the command line. For example, the syntax

```
-> lanpower 1 maxpower 40
```

reduces the power allowance of slot 1 to 40 watts. This value is now the maximum amount of power the slot can use to power all attached devices (until the value is modified by the user).

Note. Changing the maximum power available to a slot or port does not reserve or immediately allocate that power. These settings are only used for configuring a maximum amount of power that may be used, any unused power is still available and remains a part of the overall PoE budget.

Setting Port Priority Levels

As not all Powered Devices (PDs) connected to the switch have the same priority within a customer network setting, the switch allows the user to specify priority levels on a port-by-port basis. Priority levels include low, high, and critical. The default priority level for a port is low.

- **Low.** This default value is used for port(s) that have low-priority devices attached. In the event of a power management issue, inline power to low-priority is interrupted first (i.e., before critical and high-priority).
- **High.** This value is used for port(s) that have important, but *not* mission-critical, devices attached. If other in the chassis have been configured as critical, inline power to high-priority is given second priority.
- **Critical.** This value is used for port(s) that have mission-critical devices attached, and therefore require top (i.e., critical) priority. In the event of a power management issue, inline power to critical is maintained as long as possible.

To change the priority level for a particular port, use the **lanpower priority** command. Since the switch allows you to set priority levels on a port-by-port basis, be sure to specify *slot/port* information in the command line. For example, the syntax

```
-> lanpower 1/1 priority critical
```

changes the priority value of port 1 to the highest priority level of critical. Now that the default value has been reconfigured, this port should be reserved for those PDs that are mission critical for network operations.

Understanding Priority Disconnect

The priority disconnect function differs from the port priority function described on [page 6-7](#) in that it applies only to *the addition of powered devices (PDs) in tight power budget conditions*. Priority disconnect is used by the system software in determining whether an incoming PD will be granted or denied power when there are too few watts remaining in the PoE power budget for an additional device. For example, if there are only 2 watts available in the current PoE power budget and a user plugs a 3.5W powered device into a PoE port, the system software must determine whether the device will be powered on. Based on priority disconnect rules, in some cases one or more existing devices may be powered down in order to accommodate the incoming device. In other cases, the incoming device will be denied power.

Priority disconnect rules involve the port priority status of an incoming device (i.e., low, high, and critical), as well as the port's physical port number (i.e., 1/1). Understanding priority disconnect rules is especially helpful in avoiding power budget deficits and the unintentional shutdown of mission-critical devices when PDs are being added in tight power budget conditions. For detailed information on how priority disconnect uses port priority and port number criteria for determining the power status of incoming PDs, refer to the examples on pages [6-9](#) through [6-10](#).

Reminder. Priority disconnect applies only when there is inadequate power remaining in the power budget for an incoming device.

For information on setting the priority disconnect status, refer to the section below. For information on setting the port priority status (a separate function from priority disconnect), refer to [“Setting Port Priority Levels” on page 6-7](#).

Setting Priority Disconnect Status

By default, priority disconnect is *enabled* in the switch's system software. For information on changing the priority disconnect status, refer to the information below.

Disabling Priority Disconnect

When priority disconnect is disabled and there is inadequate power in the budget for an additional device, power will be denied to *any* incoming PD, regardless of its port priority status (i.e., low, high, and critical) or physical port number (i.e., 1/4).

To disable priority disconnect, use the [lanpower priority-disconnect](#) command. Since the switch allows you to set priority disconnect status on a slot-by-slot basis, be sure to specify the slot number in the command line. For example, the syntax

```
-> lanpower 1 priority-disconnect disable
```

disables the priority disconnect function on slot 1.

Enabling Priority Disconnect

To enable priority disconnect, use the [lanpower priority-disconnect](#) command. Be sure to specify the slot number in the command line. For example, the syntax

```
-> lanpower 1 priority-disconnect enable
```

enables priority disconnect on slot 1.

Priority Disconnect is Enabled; Same Priority Level on All PD

Reminder. Priority disconnect examples are applicable only when there is inadequate power remaining to power an incoming device.

When a PD is being connected to a port with the *same priority level* as all other in the slot, the physical port number is used to determine whether the incoming PD will be granted or denied power. Due to internal port numbering the following tables should be used to determine port priority, not the physical port number

Priority	1	2	3	4	5	6	7	8	9	10	11	12
Physical Port Number	11	12	9	10	7	8	5	6	3	4	1	2

Priority	13	14	15	16	17	18	19	20	21	22	23	24
Physical Port Number	23/25	24/26	21	22	19	20	17	18	15	16	13	14

Physical Port Priority Tables

Priority Disconnect is Enabled; Incoming PD Port has Highest Priority Level

Reminder. Priority disconnect examples are applicable only when there is inadequate power remaining to power an incoming device.

When a PD is being connected to a port with a *higher priority level* than all other in the slot, the incoming PD will automatically be granted power over the other devices, regardless of its physical port number.

In order to avoid a power budget deficit, another port in the slot is disconnected. In determining which port to power off, the system software first selects the port with the lowest configured priority level. For example, if a *critical priority* device is being added to a slot in which five existing devices are attached to *high priority* and one device is attached to a *low priority* port, the low priority port is automatically disconnected, regardless of its physical port number.

If all existing devices are attached to with the same lower priority level, the system software disconnects the port with both the lowest priority level *and* the highest physical port number. For example, if a critical priority device is being added to a slot in which six existing devices are attached to high priority, the high priority port with the highest physical port number is automatically disconnected.

Priority Disconnect is Enabled; Incoming PD Port has Lowest Priority Level

Reminder. Priority disconnect examples are applicable only when there is inadequate power remaining to power an incoming device.

When a PD is being connected to a port with a *lower priority level* than all other in the slot, the incoming PD will be denied power, regardless of its physical port number. Devices connected to other higher-priority will continue operating without interruption.

Priority Disconnect is Disabled

Reminder. Priority disconnect examples are applicable only when there is inadequate power remaining to power an incoming device.

When priority disconnect is disabled, power will be denied to *any* incoming PD, regardless of its port priority status (i.e., low, high, and critical) or physical port number (i.e., 1/1).

Monitoring Power over Ethernet via CLI

To monitor current PoE statistics and settings, use the **lanpower combo-port** command. The command output displays a list of all current PoE-capable, along with the following information for each port:

- Maximum power available to the port, in milliwatts
- Actual power used by the port
- Current port status
- Power priority status
- Power on/off status

Aggregate slot and chassis management information is also displayed. This information includes:

- Maximum watts available to the corresponding slot
- Amount of power budget remaining that can be available for PoE modules
- Total amount of power remaining that can be available for additional switch functions

When entering the **show lanpower** command, you must include a valid slot number in the command line syntax. For example:

```
-> show lanpower 1
-> show lanpower 1
Port Maximum(mW) Actual Used(mW) Status Priority On/Off Class
-----+-----+-----+-----+-----+-----+-----
  1      31000           0      Undefined      Low      OFF      None
  2      31000           0      Undefined      Low      OFF      None
  3      31000           0      Undefined      Low      OFF      None
  4      31000           0      Undefined      Low      OFF      None

Slot 1 Max Watts 225
1 Power Supplies Available
```

Note. For detailed information on **show lanpower** command output, refer to the *OmniSwitch CLI Reference Guide*.

7 Managing OmniSwitch 6250 Stacks

In addition to their working as individual stand-alone switches, OmniSwitch 6250 switches can also be linked together to work as a single virtual chassis known as a *stack*. With stacks, users can easily expand their switching capacity simply by adding additional switches to the stack. In addition, stacks provide enhanced resiliency and redundancy features. For more information, refer to [page 7-4](#).

In This Chapter

This chapter provides information on OmniSwitch 6250 switches configured to operate as a single virtual chassis. Topics described in the chapter include:

- OmniSwitch 6250 stack overview on [page 7-4](#).
- Roles within the stack on [page 7-4](#).
- Stack cabling on [page 7-17](#).
- Slot numbering on [page 7-20](#).
- Hot-Swapping modules in a stack on [page 7-25](#).
- Reloading switches on [page 7-27](#).
- Changing the secondary module to primary on [page 7-35](#).
- Synchronizing switches in a stack on [page 7-37](#).
- Stack Split Detection on [page 7-38](#).
- Monitoring the stack on [page 7-41](#).

Note. You can also manage and monitor OmniSwitch 6250 stacks through WebView, Alcatel-Lucent's embedded web-based device management application. WebView is an interactive and easy-to-use GUI that can be launched from OmniVista or a web browser. Please refer to WebView's online documentation for more information.

OmniSwitch 6250 Stacking Specifications

The following table lists OmniSwitch 6250 Stacking specifications.

Models Supporting Stacking	All (Metro and Enterprise switches cannot be mixed in the same stack)
Maximum Switches in a Stack	Enterprise Platforms - 8 Metro Platforms - 2
Stacking Cable Lengths (HDMI and SFP+ Copper)	30cm 60cm 150cm
Stack Split Detection (SSP)	Note: SSP Helper functionality is supported on OS6250 or OS6450.

Changing Stacking Mode on Metro Models

The OmniSwitch 6250 Metro Models non-combo fiber ports can be set to either stackable or standalone mode. By default the mode is set to standalone but can be changed in order to support stacking. **After changing the mode the switch must be rebooted.**

The following example shows how to change the mode to stackable using the [stack set slot mode](#) command.

```
-> stack set slot 1 mode stackable reload
```

Note. The HDMI stacking cables do not contain a locking mechanism. To avoid loose connections, ensure they are firmly seated.

OmniSwitch 6250 Stack Overview

Users can configure OmniSwitch 6250 switches into a single virtual chassis known as a *stack*. With stacks, switching capacity can be easily expanded simply by adding additional switches to the stack. For example, a user can start with a stack composed of two switches and add additional switches to that stack as network demands increase over time.

Note. Switches should be added one at a time in a stack.

Stacks also provide enhanced resiliency and redundancy features. If a switch in a stack goes down or is taken offline, the other elements in the stack will continue to operate without disruption. In addition, when a switch auto-synchronizes at boot-up, or if the user manually synchronizes the switches (see [“Synchronizing Switches in a Stack” on page 7-37](#) for more information), operating software and configuration parameters are backed up on all switches in the stack. As a result, the original operating software and configuration parameters can be easily recovered if corrupted or otherwise lost.

Note on Terminology. In the user guides provided with your OmniSwitch 6250 switch, the terms *stack* and *virtual chassis* are interchangeable referring to OmniSwitch 6250 switches in a stacked configuration. The terms *module*, *switch*, *slot*, and *element* are used to refer to individual switches within a stacked configuration. The terms *Chassis Management Module (CMM)* and *management module* refer to those switches operating in a stack either in the primary or secondary management roles. OmniSwitch 6250 switches operating in an idle role are essentially acting as network interface modules and therefore may be referred to as *Network Interfaces (NIs)*.

Roles Within the Stack

In order to operate as a virtual chassis, switches within an OmniSwitch 6250 stack are assigned specific roles. These roles include primary and secondary management roles, idle status, and pass-through. For detailed descriptions of each of these roles, including their practical functions within the virtual chassis, refer to the sections below.

Primary and Secondary Management Modules

When OmniSwitch 6250 switches operate in a stack, one switch in the stack always assumes the *primary management* role. This primary element is responsible for functions, such as software and configuration management, web-based management (i.e., WebView), SNMP management, switch diagnostics, and software rollback.

One additional switch in the stack operates in a *secondary management* role. This switch serves as a backup, and is always ready to assume the primary management role in the stack if the switch with the primary role fails or is taken offline for any reason.

Since the secondary module quickly and automatically assumes management responsibilities, switches operating in idle mode elsewhere in the stack continue to pass traffic without disruption. This redundancy provides effective safeguards for mission-critical network traffic and is one of the stack's most important failover features. Diagrams showing the management module failover sequence for stacks of three or more switches and stacks of two switches are provided on pages [7-5](#) and [7-6](#), respectively.

Important Note. For management module redundancy to work effectively, the software on all switches operating in the stack must be synchronized at all times. Refer to [“Synchronizing Switches in a Stack” on page 7-37](#) for more information.

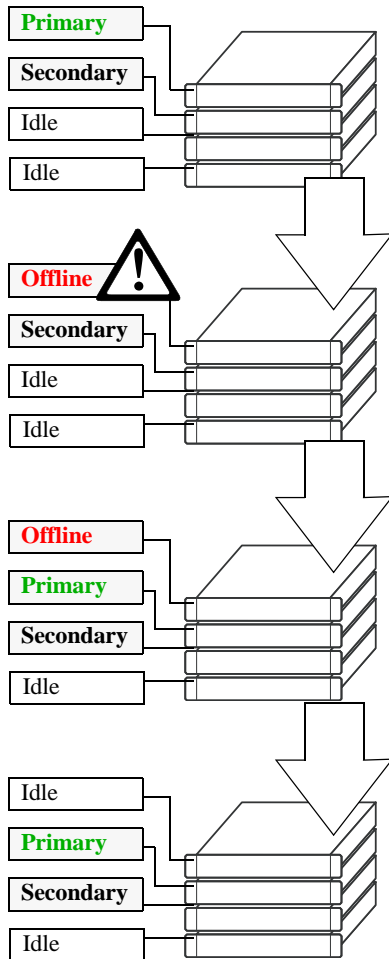

- ① A stack of four OmniSwitch 6250 switches is operating normally. The stack consists of a primary module, secondary module, and two elements operating in idle status. (The software on all elements in the stack is synchronized.)
- ② The primary management module in the stack fails or is taken offline (e.g., powered off or rebooted by the user).
- ③ The switch operating as the secondary management module immediately takes over the primary role. Meanwhile, the adjacent switch—previously operating in idle status—now assumes the secondary management role.
- ④ If the switch that failed or was taken offline comes back online, it will assume an idle role in the stack. In other words, it will act essentially as an NI module in the virtual chassis, passing traffic via its Ethernet.

Redundant Management Module Failover (Three or More Switches)

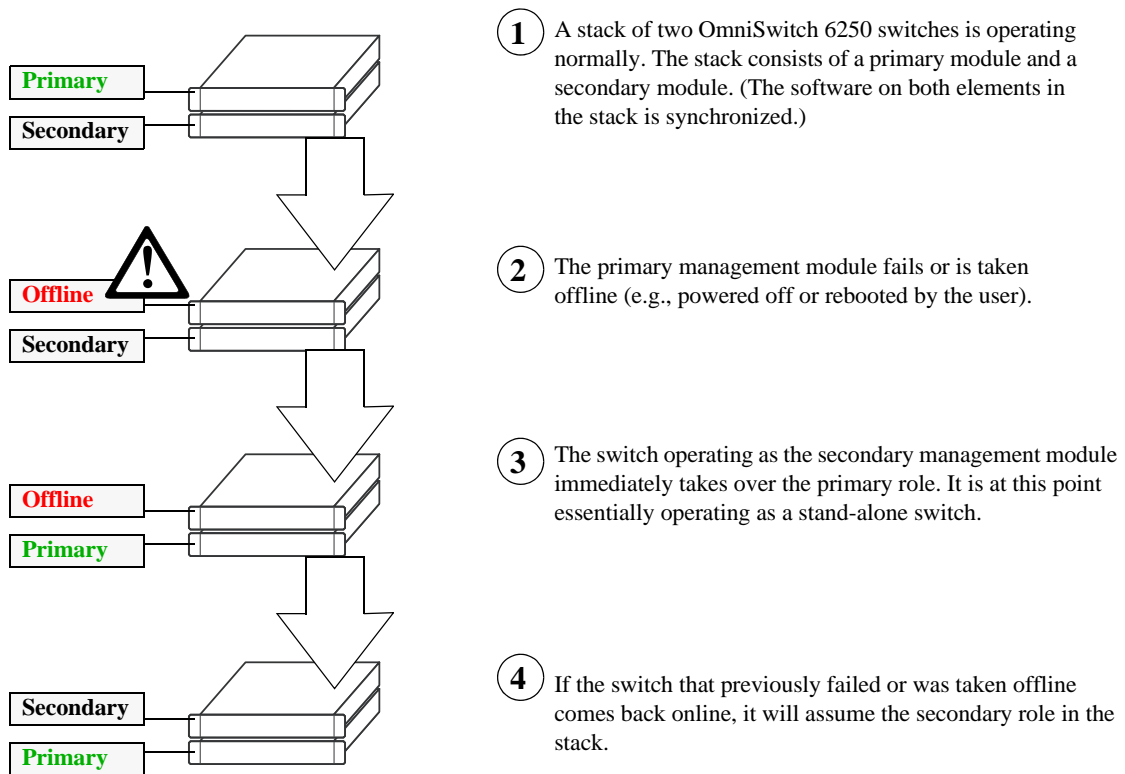

Redundant Management Module Failover (Two Switches)

Primary Management Module Selection

For a stack of OmniSwitch 6250 switches to operate as a virtual chassis, there must be a mechanism for dynamically selecting the switch within the stack that will assume the primary management role. OmniSwitch 6250 switches use three different methods for selecting the primary switch. These methods are:

- Chassis MAC address
- Saved slot number
- Chassis uptime

Note. Information on *secondary management module* selection is provided on [page 7-10](#). Information on dynamic assignment of *idle module* roles is provided on [page 7-12](#).

Using the Chassis MAC Address

By default, the primary management role will be given to the switch with the lowest chassis MAC address. However, for this to occur, all switches in the stack *must be booted within 15 seconds of each other*. In addition, switches in the stack *must have no preconfigured slot information*. Because of these two conditions, the MAC address method for selecting the primary module usually occurs with new “out of the box” switches, or switches from which any preconfigured slot information has been cleared.

For more information on using the lowest MAC address to determine the primary switch in a stack, refer to the diagram below:

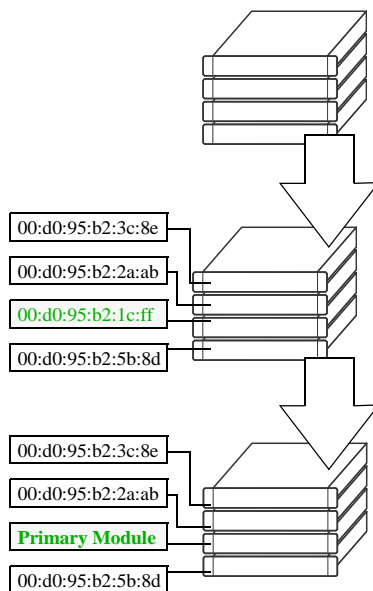

- ① A stack of four OmniSwitch 6250 switches is booted. All switches are powered on within 15 seconds of each other. In addition, there is no preconfigured slot information on any of the switches.
- ② When the stack is booted, system software detects the lowest MAC address. In this stacked configuration, the lowest MAC address is 00:d0:95:b2:1c:ff.
- ③ The system software immediately assigns the corresponding switch the primary management role. When the switch is assigned as primary, it is also dynamically assigned the lowest slot number in the stack—i.e., slot 1. This slot number information is saved to the `boot.slot.cfg` file, located in the switch's /flash file directory.

Primary Management Module Selection Using the Lowest Chassis MAC Address

Note. During the boot process, all other switches in the stack are also dynamically assigned unique slot numbers. As with the primary switch, these slot numbers are saved to the `boot.slot.cfg` file, located in the /flash file directory of each switch. For more information on dynamic slot number assignment, refer to “Slot Numbering” on [page 7-20](#).

Using Saved Slot Information

The saved slot number is the slot number the switch will assume following a reboot. This information is stored in a switch's **boot.slot.cfg** file; the switch reads its slot number assignment from this file at bootup and assumes the specified slot number within the stack.

If switches in a stacked configuration have no preconfigured slot assignments, the slot number for each switch is dynamically assigned by the system software. Slot numbers can also be manually assigned by the user. For more information on manually assigning slot numbers, refer to [“Manual Slot Number Assignment” on page 7-23](#).

When a stack with preconfigured slot information is booted, it is *not* the lowest MAC address that determines the primary management module. Instead, the slot information stored in each switch's **boot.slot.cfg** is read by the system software and used in determining the primary. The switch with the lowest saved slot number becomes the primary management module.

Note. Although, for ease-of-management purposes, it is recommended that slot numbers are assigned beginning with slot number 1, it is not a requirement. In other words, a stack of four switches can have slot assignments 3, 4, 5, and 6. However, it is important that each element in a stack is assigned a *unique* slot number. Do not assign duplicate slot numbers to elements in a stack. Otherwise, one or more switches will be forced into pass-through mode. For more information on pass-through mode, refer to [page 7-13](#).

For more information on using saved slot information to determine the primary switch in a stack, refer to the diagram below:

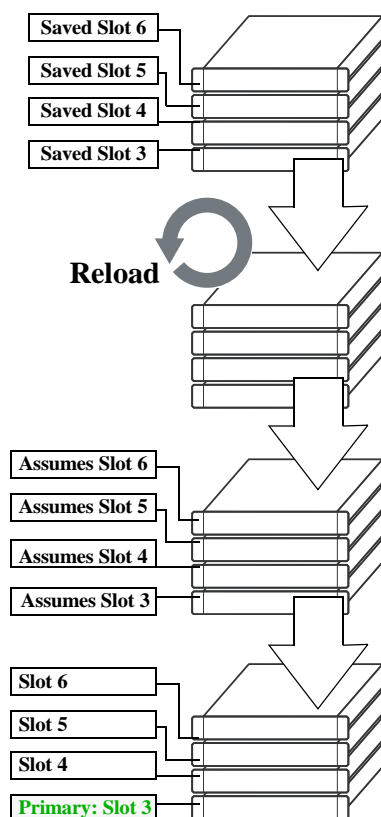

- ① Four OmniSwitch 6250 switches are stacked; all switches are connected via stacking cables. The user configures each switch to have a unique saved slot number. When each saved slot number is configured, the information is automatically written to the **boot.slot.cfg** file located in the /flash directory of each switch.
- ② The user reloads all the elements in the stack either by issuing the **reload all** command or by physically powering off and then powering on all switches.
- ③ Instead of assigning the primary management module based on the lowest MAC address, the system software reads the slot information from each switch's **boot.slot.cfg** file during the boot process. The switches in the stack come up using their assigned slot numbers.
- ④ The switch with the lowest assigned slot number automatically assumes the primary management role. In this case, the switch assigned slot 3 has the lowest slot number in the stack and becomes the primary management module.

Primary Management Module Selection Using Saved Slot Information

Using Switch Uptime

A user can override both the MAC address and saved slot methods for determining a stack's primary management module. This is done by controlling the uptime of switches in the stack. If all elements of a stack are powered off, the user can force a particular switch to become primary by powering on that switch and waiting a minimum of 15 seconds before powering on any other switches. This can be useful if the user wants a switch placed in a specific location, e.g., the top-most switch in a stack, to become the primary.

As with the lowest MAC address method, the primary management module is dynamically assigned slot number 1 when the stack is booted.

For more information on using saved slot information to determine the primary switch in a stack, refer to the diagram below:

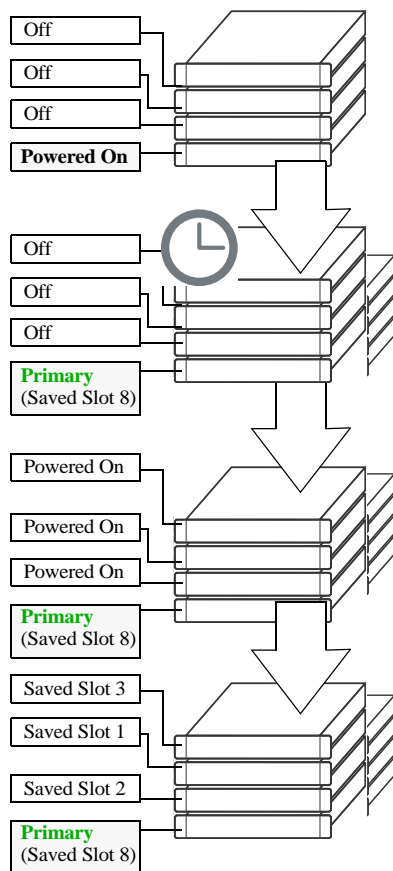

- 1 Four OmniSwitch 6250 switches are stacked and connected via stacking cables. All switches are currently powered off. The user powers on a single switch in the stack. In this case, the bottom-most switch is powered on.
- 2 The user allows a minimum of 15 seconds to pass. Because no other switches have joined the stack, the switch that was powered on considers itself a stand-alone. The switch assumes a primary role by default—even if there is a high saved slot number in its `boot.slot.cfg` file (e.g., 8).
- 3 The user now powers on the remaining switches in the stack in short succession.
- 4 In this example, when the remaining switches come online, each has a lower saved slot value than the switch powered on at step 1. However, the switch powered on at step 1—with its slot value of 8—retains its primary management role. The joining switches are essentially ineligible for primary status because they are considered “late arrivals.”

For the primary switch to forfeit its role to the switch with the lowest assigned slot number (in this case, slot number 1), the stack must be rebooted by the user either by issuing the `reload all` command or by powering off and powering on all switches in close succession.

Primary Management Module Selection Using Switch Uptime

Secondary Management Module Selection

In order to provide effective management module redundancy, all OmniSwitch 6250 stacked configurations dynamically assign a backup, or secondary, management module during the boot process. OmniSwitch 6250 stacks use two different methods for selecting the secondary switch. These methods are:

- Stacking connection to the primary switch
- Saved slot number

Using the Stacking Connection to the Primary Switch

By default, the switch that is connected to the primary switch's stacking port A is automatically assigned the secondary management role. This applies to stacks on which there is no preassigned slot information—i.e., there is no `boot.slot.cfg` file present in any switch.

For more information on using the stacking connection to the primary switch to determine the secondary management module, refer to the diagram below:

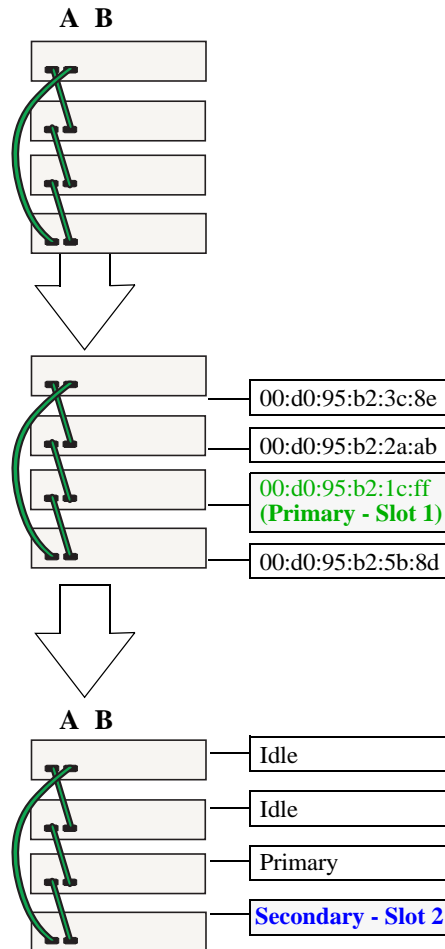

① Four OmniSwitch 6250 switches are stacked and connected via stacking cables, as shown. All switches are currently powered off. None of the switches have preassigned slot numbers—i.e., there are no `boot.slot.cfg` files present. The user powers on all switches in the stack in close succession and the stack begins the boot process.

② When the elements in the stack come online, the switch with the lowest MAC address is given the primary management role and is dynamically assigned slot number 1.

③ By default, the switch connected to the primary's stacking port A is automatically assigned the secondary management role. The secondary switch is dynamically assigned slot number 2.

Secondary Management Module Selection Using the Stacking Connection to the Primary Switch

Note. For information on dynamic slot numbering for idle elements within the stack, refer to [“Idle Module Role” on page 7-12](#) and [“Slot Numbering” on page 7-20](#).

Using Saved Slot Information

If a stack with preassigned slot information for each switch is booted, the switch with the *second lowest* slot value is assigned the secondary management role. For example, if a stack of four switches is booted and the preassigned slot values for each switch are 1, 2, 3, and 4, the switch with the slot value of 2 is assigned the secondary role. Meanwhile, the switch with the slot value of 1 is assigned the primary management role (see [page 7-8](#)).

For more information on using saved slot information to determine the secondary management module in a stack, refer to the diagram below:

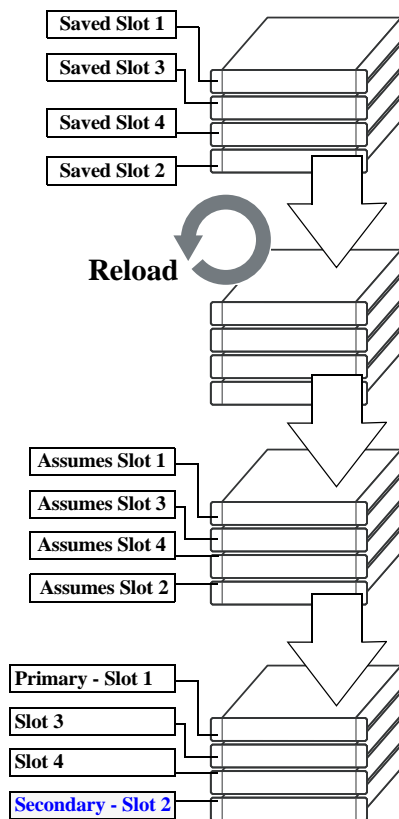

- ① Four OmniSwitch 6250 switches are stacked; all switches are connected via stacking cables. The user configures each switch to have a unique saved slot number, as shown. When the saved slot number is configured, the information is automatically written to the **boot.slot.cfg** file located in the /flash directory of each switch.
- ② The user reloads all the elements in the stack either by issuing the **reload all** command or by physically powering off and then powering on all switches.
- ③ The system software reads the slot information from each switch's **boot.slot.cfg** file during the boot process. The switches in the stack come up using their assigned slot numbers.
- ④ The switch with the lowest assigned slot number automatically assumes the primary management role. The switch with the *second lowest* assigned slot number becomes the secondary management role, regardless of whether it is attached to stacking port A of the primary switch. In this case, the switch assigned slot 2 has the second-lowest slot number in the stack and becomes the secondary management module.

Secondary Management Module Selection Using Saved Slot Information

Reminder. Each element in a stack should always be assigned a *unique* slot number. Do not assign duplicate slot numbers to elements in a stack. Otherwise, one or more switches will be forced into pass-through mode. For more information on pass-through mode, refer to [page 7-13](#).

Idle Module Role

Switches that are not assigned either the primary or secondary role in a stack are, by default, assigned the role of *idle* modules. These idle modules operate similarly to Network Interface (NI) modules in a chassis-based switch. It is the job of idle modules to send and receive traffic.

In the event of a management module failure within the stack, the idle module with the next lowest slot number in the stack will automatically assume the secondary management role. In other words, if the primary module in a stack goes down for any reason and the secondary takes over the primary management role, the switch must now assign a new secondary module. The idle element with the next lowest slot number assumes this new responsibility until the situation is corrected and all elements in the stack are reloaded.

Note. Primary and secondary management modules also send and receive traffic on their Ethernet. The primary management module is like an NI module with the added task of overall stack management; the secondary management module is like an NI with the added responsibility of backing up the primary module in the event of a primary module failure. In other words, *all modules* in the virtual chassis can send and receive user data, regardless of their roles.

For more information on dynamic assignment of idle modules in a stack, refer to the diagram below:

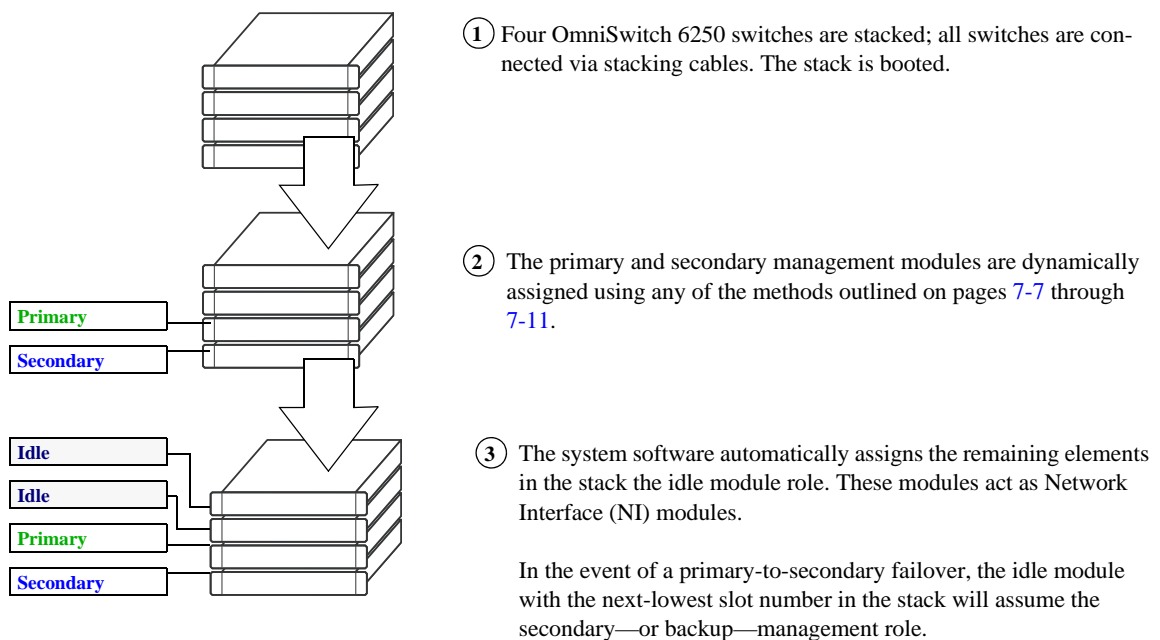

Secondary Management Module Selection Using Saved Slot Information

Pass-Through Mode

The pass-through mode is a state in which a switch has attempted to join a stack but has been denied primary, secondary, and idle status. When a switch is in the pass-through mode, its Ethernet ports are brought down (i.e, they cannot pass traffic). Its stacking cable connections remain fully functional and can pass traffic through to other switches in the stack. In this way, the pass-through mode provides a mechanism to prevent the stack ring from being broken. However, note that when a switch comes up in pass-through mode, it should not be left unresolved. Pass-through mode is essentially an error state that should be corrected immediately.

Note. When a switch is in pass-through mode, its information will not display in hardware monitoring commands such as **show chassis**, **show ni**, **show module**, etc.

Conditions that can trigger a switch to enter pass-through mode include:

- Duplicate slot numbers have been assigned within the stack
- The user has manually forced the switch into pass-through mode using the **stack clear slot** command

Note. If a switch is forced into pass-through mode, the rest of the stack will not be disrupted. Any elements in the stack *not* operating in pass-through mode continue to operate normally.

The most common reason for one or more switches to enter pass-through is duplicate slot number assignments within the stack. So, in order to avoid pass-through mode, it is useful to keep track of the current saved slot numbers on all elements in the stack. Slot number assignments are stored in the **boot.slot.cfg** file in the /flash directory of each switch.

If the stack is booted and the same slot number is discovered on two or more switches, the switch with the lowest MAC address is allowed to come up and operate normally. Meanwhile, switches with the duplicate slot number *and* a higher MAC address come up in pass-through mode. To check the current slot number stored in each switch's **boot.slot.cfg** file, use the **show stack topology** command. For example:

```
-> show stack topology
```

NI	Role	State	Saved Slot	Link A State	Link A Remote NI	Link A Remote Port	Link B State	Link B Remote NI	Link B Remote Port
1	PRIMARY	RUNNING	1	UP	3	StackA	UP	2	StackA
2	SECONDARY	RUNNING	2	UP	1	StackB	UP	3	StackB
3	IDLE	RUNNING	2	UP	1	StackA	UP	2	StackB

In this example, note that both slots 2 and 3 have a saved slot value of 2. If this stack is rebooted, a duplicate slot error will occur and the switch with the lower MAC address will be given the secondary management role. The slot with the higher MAC address will be forced into the pass-through mode.

To avoid a pass-through condition following a reboot, make sure that all saved slot values for the stack are unique. Use the **stack set slot** command. For example, change the saved slot value for the idle switch in slot 3 from 2 to 3:

```
-> stack set slot 3 saved-slot 2
```

Use the **show stack topology** command to verify the change:

```
-> show stack topology
```

NI	Role	State	Saved Slot	Link A State	Link A Remote NI	Link A Remote Port	Link B State	Link B Remote NI	Link B Remote Port
1	PRIMARY	RUNNING	1	UP	3	StackA	UP	2	StackA
2	SECONDARY	RUNNING	2	UP	1	StackB	UP	3	StackB
3	IDLE	RUNNING	3	UP	1	StackA	UP	2	StackB

Recovering from Pass-Through Mode (Duplicate Slot Numbers)

The first step in recovering from pass-through is to determine which modules are currently operating in pass-through, as well as the reason for the pass-through state. To view this information, use the **show stack topology** command. For example:

```
-> show stack topology
```

NI	Role	State	Saved Slot	Link A State	Link A Remote NI	Link A Remote Port	Link B State	Link B Remote NI	Link B Remote Port
1	PRIMARY	RUNNING	1	UP	1001	StackA	UP	2	StackA
2	SECONDARY	RUNNING	2	UP	1	StackB	UP	1001	StackB
1001	PASS-THRU	DUP-SLOT	2	UP	1	StackA	UP	2	StackB

Switches operating in pass-through mode are given distinct slot numbers. These slot numbers are not related to their position in the stack. Instead, they are assigned the prefix “100,” followed by the numerical order in which they were forced into pass-through (1001–1008).

Note. For pass-through elements 1001 through 1008, the slot indicator LED on the chassis front panel blinks 1 through 8, respectively. For example, if a module enters pass-through and has the slot number 1004, the LED for the module blinks the number 4. For more information on the slot indicator LED, refer to [“LED Status” on page 3-20](#).

In the example above, the switch with the NI (i.e., slot) number 1001 is operating in pass-through. Note that the role assignment is PASS-THRU; also, the state displays DUP-SLOT, or *duplicate slot number*. This can be further verified by looking down the saved slot column in the table. Note that slot 2, operating in the secondary management role, has a saved slot value of 2. Slot 1001, operating in pass-through, also has a saved slot value of 2.

To resolve this pass-through condition, simply assign slot 1001 a new saved slot value and reboot the module. This can be done in either of two ways:

- Use the **stack set slot** command to assign the new value, then use the **reload pass-through** command to reboot the module:

```
-> stack set slot 1001 saved-slot 3
-> reload pass-through 1001
```

- Use the **stack set slot** command to assign the new slot value and, using the optional **reload** syntax in the command line, reboot the module:

```
-> stack set slot 1001 saved-slot 3 reload
```

When the module comes up, it assumes the new, unique slot position—in this case, slot 3—and, because it now has the highest slot number in the stack, it assumes an idle role (leaving the primary and secondary roles to slots 1 and 2, respectively). There are now no duplicate numbers in the stack and all elements are operating normally:

```
-> show stack topology
```

NI	Role	State	Saved Slot	Link A State	Link A Remote NI	Link A Remote Port	Link B State	Link B Remote NI	Link B Remote Port
1	PRIMARY	RUNNING	1	UP	3	StackA	UP	2	StackA
2	SECONDARY	RUNNING	2	UP	1	StackB	UP	3	StackB
3	IDLE	RUNNING	3	UP	1	StackA	UP	2	StackB

In some pass-through conditions (for example, larger stacks where multiple switches are in pass-through mode), it might be desirable to correct any duplicate saved slot assignments and then reboot the entire stack. The recovery from pass-through can be accomplished with fewer steps than reassigning slot numbers and rebooting modules on a slot-by-slot basis. However, be sure that there is no mission-critical traffic being passed on the non-pass-through modules; traffic will be interrupted on these modules during the reboot.

The following example shows a large stack with multiple elements operating in pass-through mode:

```
-> show stack topology
```

NI	Role	State	Saved Slot	Link A State	Link A Remote NI	Link A Remote Port	Link B State	Link B Remote NI	Link B Remote Port
4	IDLE	RUNNING	4	UP	5	StackB	UP	3	StackA
5	IDLE	RUNNING	5	UP	1001	StackB	UP	4	StackA
1001	PASS-THRU	DUP-SLOT	2	UP	2	StackB	UP	5	StackA
2	SECONDARY	RUNNING	2	UP	1003	StackB	UP	1001	StackA
1003	PASS-THRU	DUP-SLOT	2	UP	1002	StackB	UP	2	StackA
1002	PASS-THRU	DUP-SLOT	2	UP	1	StackB	UP	1003	StackA
1	PRIMARY	RUNNING	1	UP	3	StackB	UP	1002	StackA
3	IDLE	RUNNING	3	UP	4	StackB	UP	1	StackA

This disordered stack topology, with its three modules operating in pass-through mode, can be corrected by entering the following commands:

```
-> stack set slot 4 saved-slot 1
-> stack set slot 5 saved-slot 2
-> stack set slot 1001 saved-slot 3
-> stack set slot 2 saved-slot 4
-> stack set slot 1003 saved-slot 5
-> stack set slot 1002 saved-slot 6
-> stack set slot 1 saved-slot 7
-> stack set slot 3 saved-slot 8
-> reload all
```

When all elements in the stack come up following the reboot, there are no longer any duplicate slot numbers in the stack. In addition, the stack topology is more orderly and, as a result, easier to manage:

```
-> show stack topology
```

NI	Role	State	Saved Slot	Link A State	Link A Remote NI	Link A Remote Port	Link B State	Link B Remote NI	Link B Remote Port
1	PRIMARY	RUNNING	1	UP	2	StackB	UP	8	StackA
2	SECONDARY	RUNNING	2	UP	3	StackB	UP	1	StackA
3	IDLE	RUNNING	3	UP	4	StackB	UP	2	StackA
4	IDLE	RUNNING	4	UP	5	StackB	UP	3	StackA
5	IDLE	RUNNING	5	UP	6	StackB	UP	4	StackA
6	IDLE	RUNNING	6	UP	7	StackB	UP	5	StackA
7	IDLE	RUNNING	7	UP	8	StackB	UP	6	StackA
8	IDLE	RUNNING	8	UP	1	StackB	UP	7	StackA

Stack Cabling

Switches in a stack are connected to each other by stacking cables. These stacking cables provide high-speed, dual-redundant links between switches in a stack.

Stacking cables for OmniSwitch 6250 switches must be connected in an **A-B** pattern. In other words, the cable connected to stacking port **A** of one switch must be connected to stacking port **B** of the adjacent switch. In addition, for a stack to have effective redundancy, *a redundant stacking cable must be installed between the upper-most and bottom-most switch at all times*. This provides effective failover in the event of a stacking link or module failure within the stack.

The diagram below shows the required stacking cable pattern. For detailed information on assembling a stack and connecting the cables, refer to [Chapter 3, “OmniSwitch 6250 Chassis and Hardware Components.”](#)

Note. When planning the stack cabling configuration, keep in mind that the switch connected to stacking port A of the primary switch will be assigned the secondary management role by default.

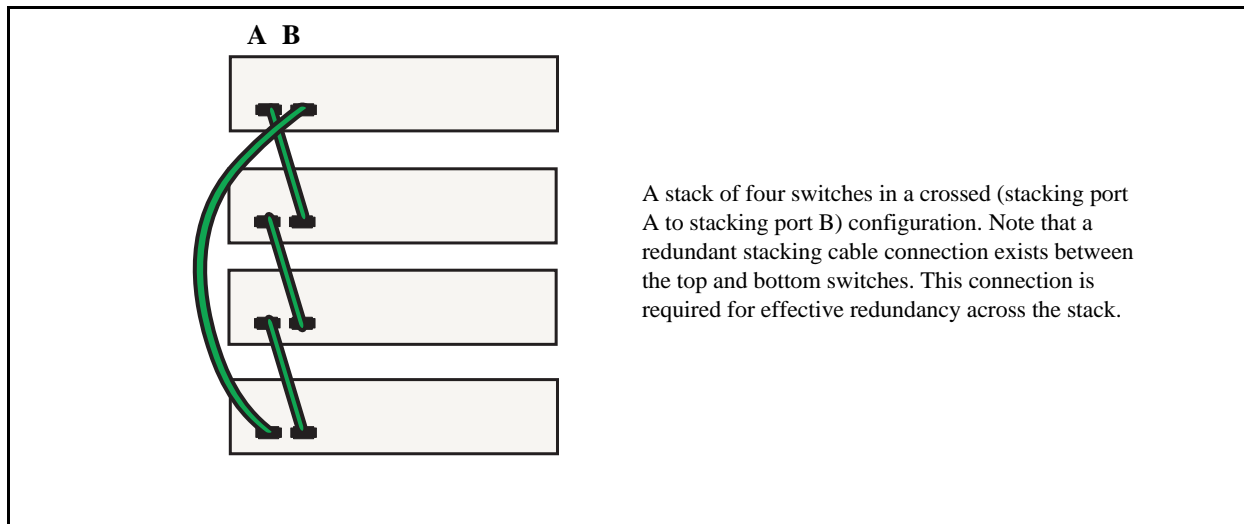

Example of Stacking Cable Pattern (Chassis Rear Panels Shown)

Note. The HDMI stacking cables do not contain a locking mechanism. To avoid loose connections, ensure they are firmly seated.

Redundant Stacking Cable Connection

OmniSwitch 6250 switches allow redundant stacking cable connections between the top-most and bottom-most switches in a stack.

Important. For a stacked configuration to have effective redundancy, a redundant stacking cable must be installed between the upper-most and bottom-most switch in the chassis at all times.

The figure below shows how the redundant connection between the top and bottom switches in the stack ensures that data will continue to flow throughout the stack, even in the event of a connection failure at one of the stacking cables.

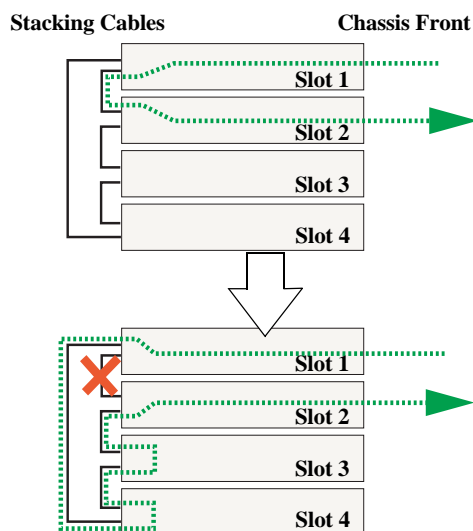

1 Data enters slot 1 via an Ethernet port. The data is passed to slot 2 over the stacking cable connection, then exits slot 2 via one of its Ethernet ports.

2 The stacking connection between slots 1 and 2 goes down unexpectedly. Data can no longer travel directly between slot 1 and 2.

However, because there is a redundant connection (the cable between slot 1 and slot 4), data is immediately passed to slot 4, then quickly traverses slot 3 and exits slot 2 to its destination.

Stacking Cable Redundancy: Recovery Following a Stacking Link Failure

Redundant stacking cables provide a form of *dual* redundancy. As shown in the figure above, the redundant cable allows traffic to flow in the event of a stacking link failure. The redundant cable also provides failover if a *switch* goes down within the stack. Traffic continues to flow between the modules that remain operational, as shown in the diagram below:

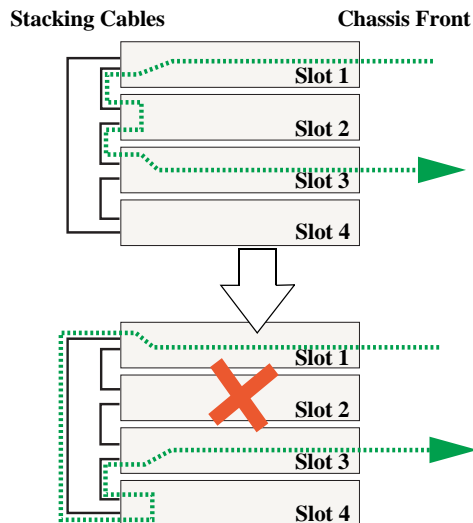

① Data enters slot 1 through an Ethernet port. The data traverses slot 2 via the stacking cables and exits slot 3 through one of its Ethernet ports.

② The slot 2 switch goes down unexpectedly. Data can no longer move through slot 2.

However, because there is a redundant connection (the cable between slot 1 and slot 4), data immediately traverses slot 4 and then exits slot 3 to its destination.

Stacking Cable Redundancy: Recovery Following a Switch Failure within the Stack

Checking Redundant Stacking Cable Status

To check whether a redundant stacking cable connection exists between the top-most and bottom-most switches in the stack, use the `show stack status` command. For example:

```
-> show stack status
Redundant cable status : present
```

In this example, a redundant stacking cable connection is present between the top-most and bottom-most switches in the stack.

Slot Numbering

For a stack of OmniSwitch 6250 switches to operate as a virtual chassis, each module in the stack must be assigned a unique slot number. To view the current slot assignments for a stack, use the **show ni** or **show module** commands. The slot number is also displayed on the front panel of each switch by the LED located on the left side of the chassis (refer to “**LED Status**” on page 3-20 for more information).

There are two ways stacking modules are assigned slot numbers:

- Dynamic slot number assignment by the system software
- Manual slot number assignment by the user

Dynamic Slot Number Assignment

Dynamic slot number assignment occurs when there are no **boot.slot.cfg** files present in the switches' /flash directories. This is the case for new, "out of the box," switches that have not been previously booted.

When a brand new stack (or stack with no **boot.slot.cfg** files) is booted, the system software automatically detects the module with the lowest MAC address. This module is assigned the primary management role (see [page 7-4](#)) and, by default, is given the slot number 1. The module connected to the primary's stacking port A is automatically assigned the secondary management role and given the slot number 2.

As the other modules in the stack become operational, they are assigned idle roles and are automatically assigned unique slot numbers. The slot numbering for idle modules is determined by each module's physical location in the stack. Refer to the diagrams below for more information on dynamic slot numbering.

Note. As the slot numbers are dynamically assigned, **boot.slot.cfg** files are auto-generated in the /flash directory of each switch. When modules are subsequently booted, each switch reads its slot number assignment from this file and comes up accordingly.

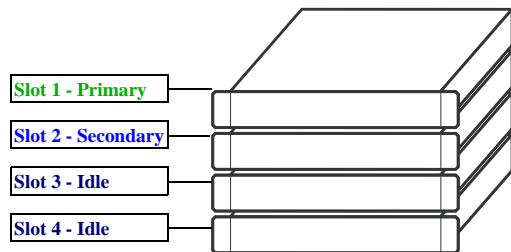

In this example, the fourth switch from the top is elected the primary management module for the stack. (It can be assumed that this switch has the lowest MAC address in the stack.) This switch is automatically assigned slot number 1.

The switch immediately below is connected to the primary switch's stacking port A and, as a result, is assigned the secondary management role and given slot number 2.

The system software allows the switch immediately below slot 2 to have the next slot number preference. It is assigned an idle role and given the slot number 3. The switch immediately below slot 3 is given the slot number 4, and so on. When the bottom of the stack is reached, the slot numbering sequence resumes at the top of the stack, as shown. This helps ensure a more ordered and manageable stack topology.

Dynamic Slot Numbering Example 1

If the switch with the lowest MAC address happens to be the bottom-most module in the stack, slot numbering will not resume from the top of the stack. Instead, the system software will select the secondary module using the standard method (i.e., the switch connected to the primary's stacking port A), then continue to number the stack from the bottom up. This intuitive slot assignment provides the cleanest and most manageable stack topology. Refer to the diagram below for more information:

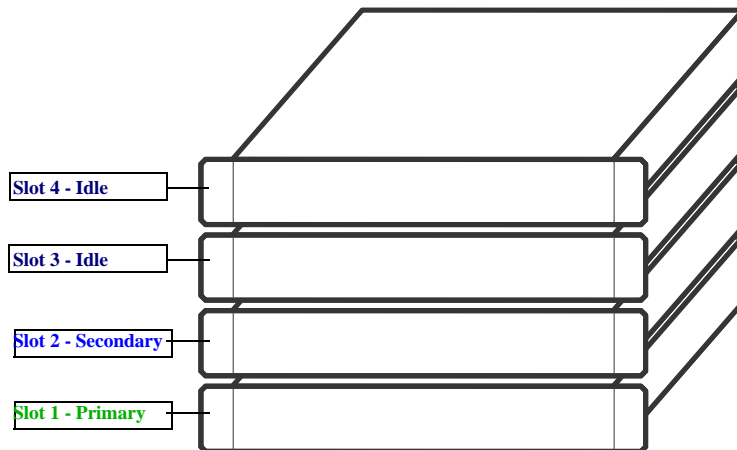

In this example, the bottom switch is elected the primary management module for the stack. (It can be assumed that this switch has the lowest MAC address in the stack.) This switch is automatically assigned slot number 1.

The switch immediately above is connected to the primary switch's stacking port A and, as a result, is assigned the secondary management role and given slot number 2.

The system software then sequentially assigns slot numbers up the stack. In other words, the switch immediately above slot 2 is assigned the slot number 3; the switch immediately above slot 3 is assigned the slot number 4, and so on. This default procedure ensures the most ordered and manageable stack topology out of the box.

Dynamic Slot Numbering Example 2

Manual Slot Number Assignment

To manually assign slot numbers to one or more modules in a stack, use the **stack set slot** command. This command writes slot information to the **boot.slot.cfg** file located in a switch's /flash directory. It is this *saved slot* information that the switch will assume following a reboot.

Manually assigning slot numbers can be useful in reordering existing slot numbers in order to create a sequential numbering scheme from the top of the stack to the bottom (or vice-versa). Refer to the following example:

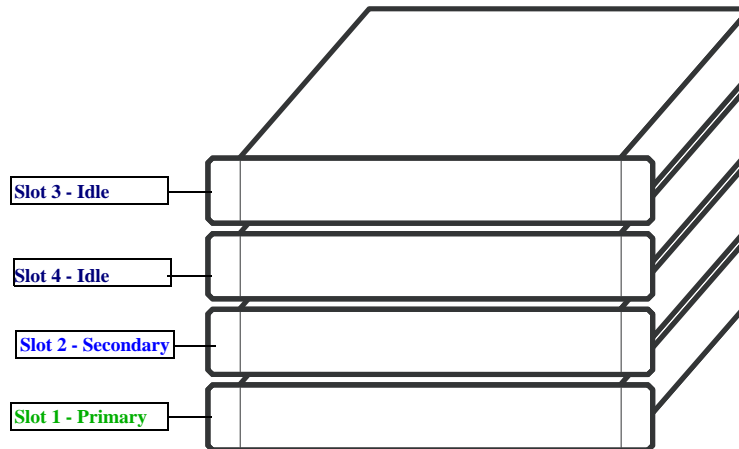

Stack Numbering Before Manual Assignment

This example, taken from [page 7-21](#), shows a stack in which the primary and secondary switches are physically positioned in the middle of the stack. Although the stack will operate normally with this primary and secondary module positioning, it may be preferable for management purposes to have the primary and secondary switches at either the top or the bottom of the stack. For this example, the primary and secondary roles will be assigned to the top of the stack. This is accomplished by entering the following commands:

```
-> stack set slot 3 saved-slot 1
-> stack set slot 4 saved-slot 2
-> stack set slot 2 saved-slot 3
-> stack set slot 1 saved-slot 4
-> reload all
```

Because slot 3 is the top-most switch in the stack, it is reassigned the slot 1 (i.e., primary) position; because slot 4 is located immediately below slot 3, it is reassigned the slot 2 (i.e., secondary) position, etc.

Note that the modules were not reloaded one-by-one, even though the **stack set slot** command provides optional syntax for doing so. Instead, new slot number information is first saved to each **boot.slot.cfg** file across the stack. The reboot is saved for last in order to avoid duplicate slot numbers within the stack, which would cause unwanted pass-through mode conditions (see [page 7-13](#)).

When the stack comes up following the reboot, the manually-configured slot numbers display as follows:

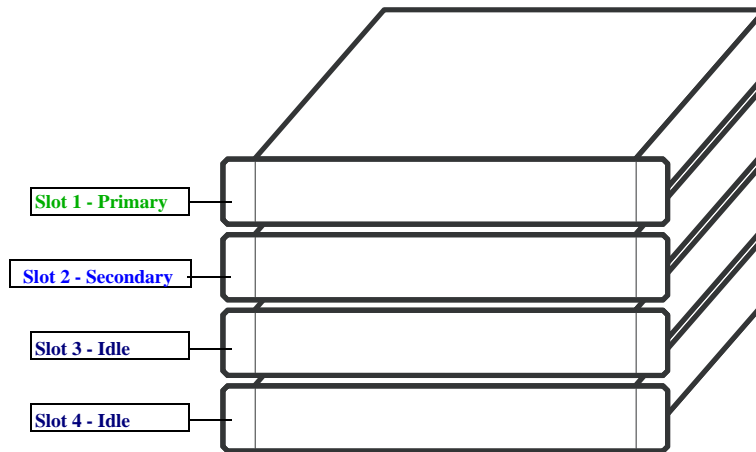

Stack Numbering Before Manual Assignment

The **stack set slot** command can also be used to manually correct duplicate saved slot assignments within the stack topology. Refer to pages [7-13](#) through [7-15](#) for detailed information.

Reverting to the Dynamic Slot Numbering Model

To clear the **boot.slot.cfg** files from the stack's /flash directories, use the **stack clear slot** command on all modules and then reboot the stack. For example:

```
-> stack clear slot 1
-> stack clear slot 2
-> stack clear slot 3
-> stack clear slot 4
-> reload all
```

The commands shown above clear the saved slot information from all modules in an eight-module stacked configuration and then reboot the stack. Because the system software no longer has preassigned slot information to read during the boot process, the stack uses the dynamic slot number assignment method described on [page 7-21](#).

Hot-Swapping Modules In a Stack

As with chassis-based switches, NI modules within an OmniSwitch 6250 virtual chassis are hot-swappable. NI modules are essentially those modules operating in the stack in idle mode. These modules can be removed from, or added to, an existing stack without disrupting other modules in the stack.

Removing Switches from an Existing Stack

When removing switches from an existing stack, observe the following important guidelines:

- Do not attempt to hot-swap modules operating in primary or secondary management roles
- Be sure the stacking cables and stacking cable redundancy are not disrupted

Hot-swapping is intended for switches in *idle* and, if applicable, *pass-through* status only. Removing primary or secondary management modules from a stack will trigger a failover sequence, i.e., one or more additional modules within the stack must reload in order to reassign the management roles. Whenever possible, avoid removing a switch that is operating as a primary or secondary management module.

Also, removing a switch from a stacked configuration can disrupt stack cabling at the rear of the stack. When removing a module, be sure that stacking link integrity, including important stacking cable redundancy, is maintained between all remaining modules. For more information on stacking cable connections, refer to [page 7-17](#).

Inserting Switches Into an Existing Stack

When inserting switches into an existing stack, observe the following important guidelines:

- Avoid duplicate saved slot numbers
- Never attempt to operate more than the supported number of switches in a single stack
- Make sure all switches are running the same software version.

To avoid duplicate slot numbers, simply make sure that any modules being added to an existing stack have been cleared of preassigned slot information. In other words, verify that there is no **boot.slot.cfg** file present in the /flash directory of any switch being added. When the switch is connected to the existing stack and booted, the system software automatically assigns it a unique slot number. No duplicate slot errors occur.

Note. If it is preferable to add a switch with an existing **boot.slot.cfg** file to a stack, be sure that the saved slot number of the incoming switch is not already assigned to a switch operating in the stack.

Merging Stacks

Merging stacks involves connecting two or more operational stacks and attempting to reboot them as a single virtual chassis. In most cases, errors will result. To merge stacks without causing errors, select one stack that is to remain up and running and then add modules from the other stack(s) by following the steps below:

- 1 Make sure all switches are running the same software version.
- 2 Clear the saved slot information from all incoming modules. This will ensure that they are each assigned unique slot numbers when they join the stack.
- 3 After clearing the saved slot information, power off all incoming modules.
- 4 Connect the stacking cables for all incoming modules to the existing, operational stack as required. Be sure to provide stacking cable redundancy. For information on stack cabling, refer to [page 7-17](#).
- 5 Power on all incoming modules.

Note. No more than eight switches can operate in a single stacked configuration at any time.

Reloading Switches

Reloading is essentially a soft boot of a switch. Users can reload stacked modules operating in any role—i.e., primary, secondary, idle, and pass-through. Refer to the sections below for more information.

Reloading the Primary Management Module

If the switch with the primary management role is reloaded, the switch with the secondary role automatically takes over primary management functions. In other words, the switch with the secondary role assumes the primary role as soon as the reload is initiated.

Meanwhile, the idle switch with the next lowest slot number automatically assumes the secondary role. When the reloaded switch (the former primary module) comes back up, it assumes an idle role within the stack.

To reload the primary management module, use the **reload** command. The optional syntax **primary** can be used in the command line, but is not required. For example:

```
-> reload primary
```

Note. A primary management module reload can also be scheduled for a later time or date. For information on scheduling a primary module reload, as well as additional command details, refer to the *OmniSwitch CLI Reference Guide*.

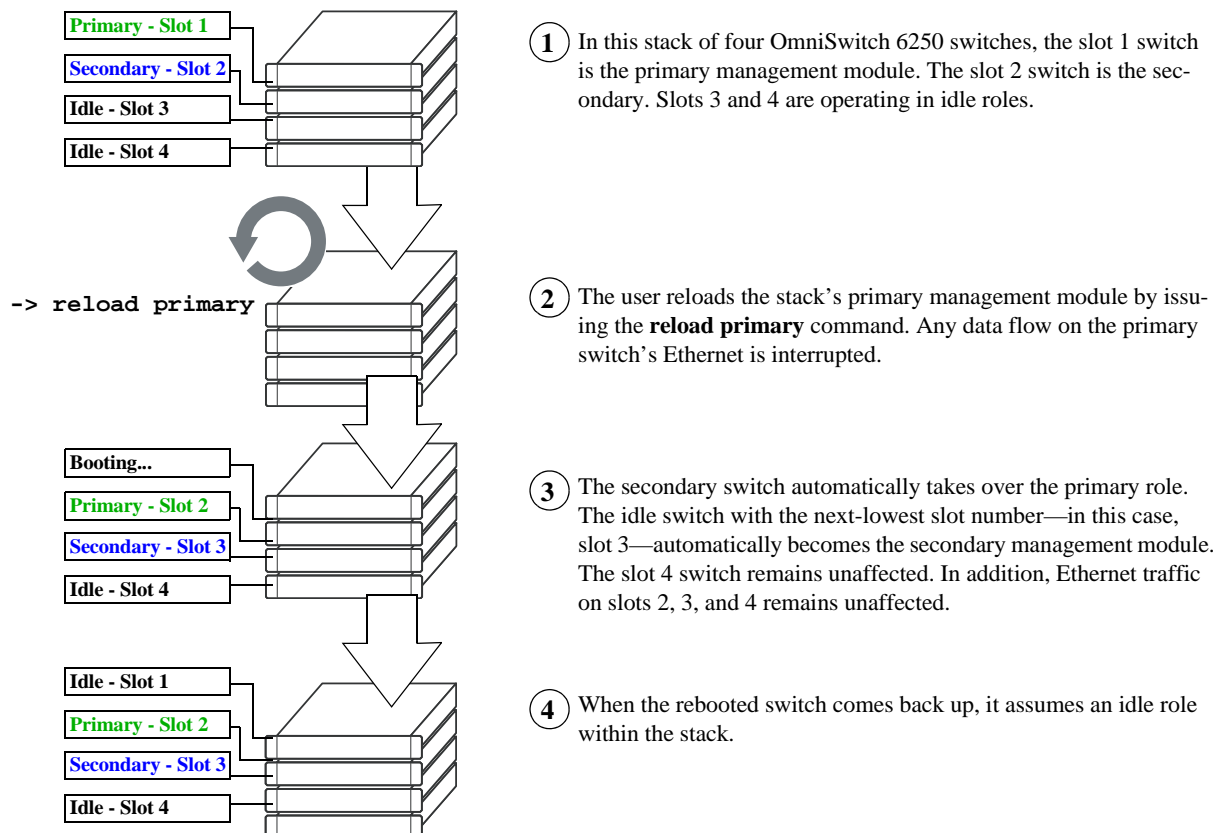

Reloading the Primary Management Module In a Stack of Three or More

If there are only two switches in the stack, the switch that was reloaded (the former primary) assumes the secondary role when it comes back up.

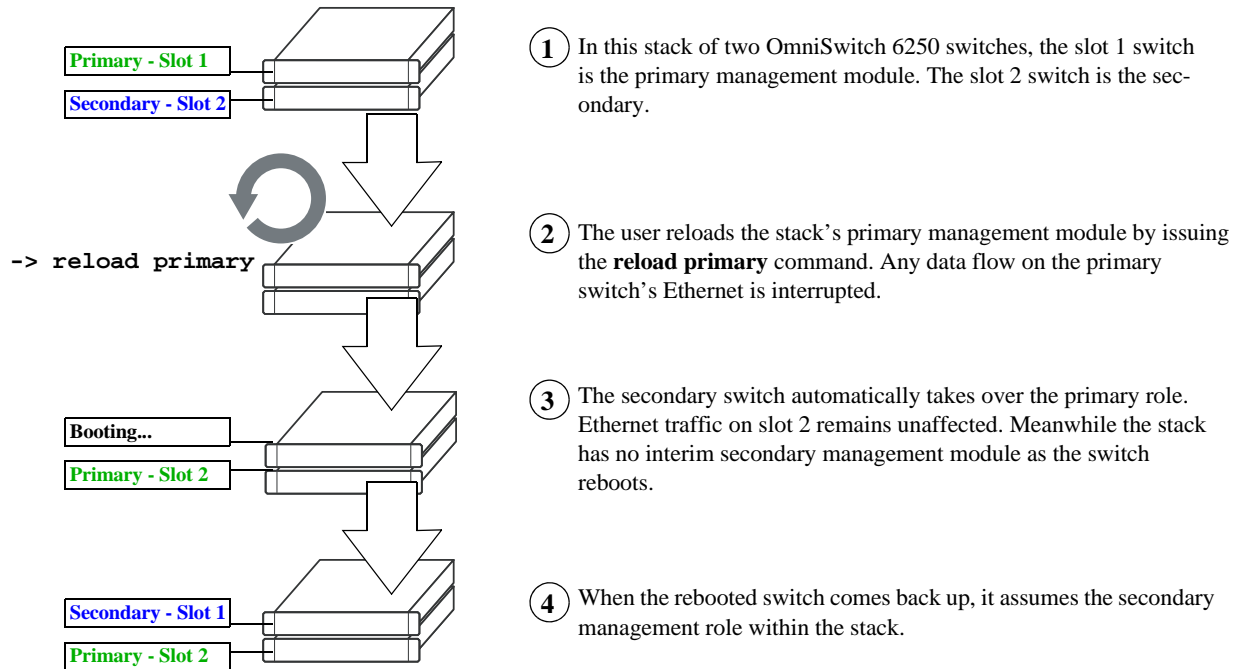

- ① In this stack of two OmniSwitch 6250 switches, the slot 1 switch is the primary management module. The slot 2 switch is the secondary.
- ② The user reloads the stack's primary management module by issuing the **reload primary** command. Any data flow on the primary switch's Ethernet is interrupted.
- ③ The secondary switch automatically takes over the primary role. Ethernet traffic on slot 2 remains unaffected. Meanwhile the stack has no interim secondary management module as the switch reboots.
- ④ When the rebooted switch comes back up, it assumes the secondary management role within the stack.

Reloading the Primary Management Module In a Stack of Two

Reloading the Secondary Management Module

If the switch with secondary management role is reloaded, the idle switch with the lowest slot number will automatically assume the secondary role. The reloaded switch (the former secondary) will assume an idle role when it comes back up.

Meanwhile, the switch with the primary management role, as well as any other idle modules in the stack, continue operations without interruption.

To reload the secondary management module, use the **reload** command. Be sure to include the syntax **secondary** in the command line. For example:

```
-> reload secondary
```

Note. A secondary management module reload can also be scheduled for a later time or date. For information on scheduling a secondary module reload, as well as additional command details, refer to the *OmniSwitch CLI Reference Guide*.

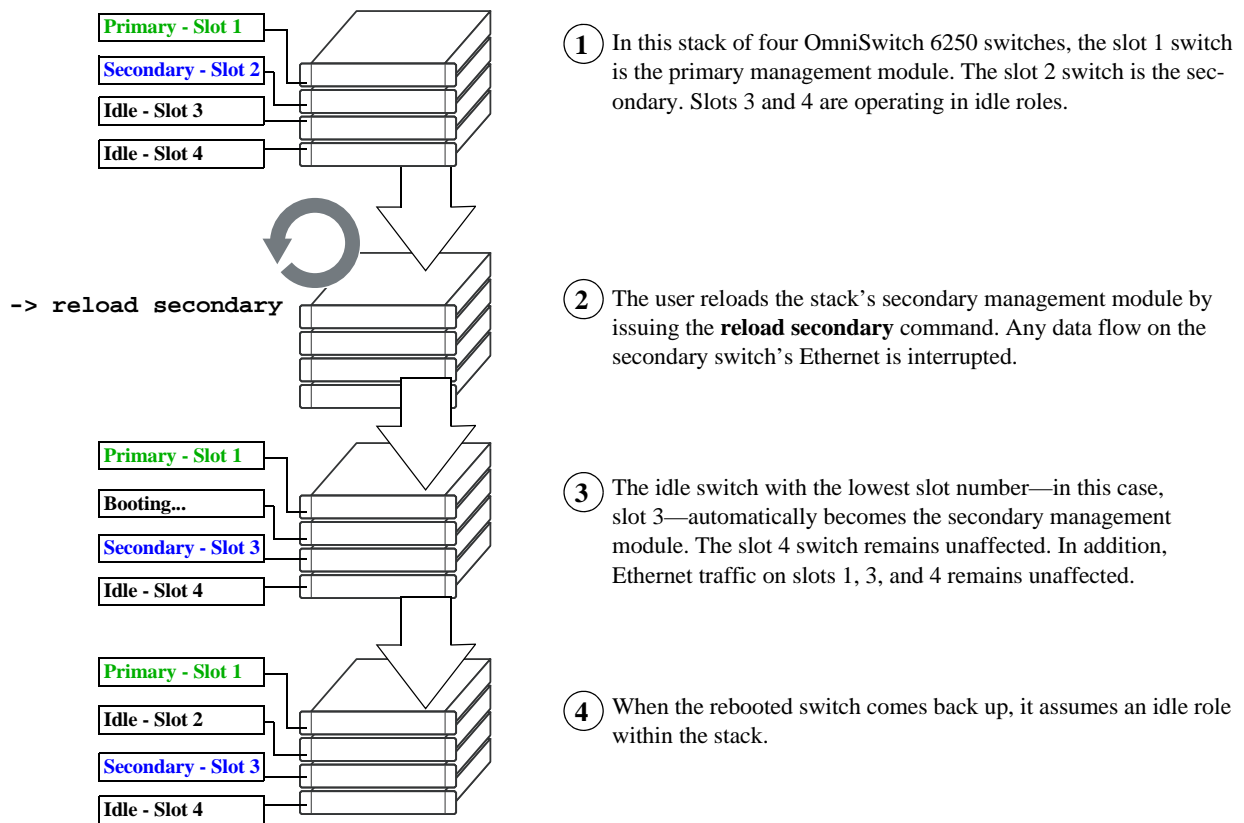

Reloading the Secondary Management Module In a Stack of Three or More

If there are only two switches in the stack, the switch that was reloaded (the former secondary) resumes the secondary role when it comes back up.

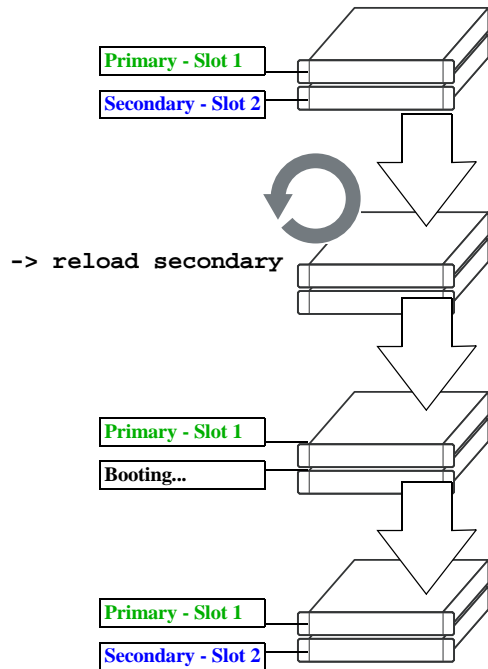

① In this stack of two OmniSwitch 6250 switches, the slot 1 switch is the primary management module. The slot 2 switch is the secondary.

② The user reloads the stack's secondary management module by issuing the **reload secondary** command. Any data flow on the secondary switch's Ethernet is interrupted.

③ As the secondary switch reboots, the primary management module continues to operate without interruption. Meanwhile the stack has no interim secondary management module as the switch reboots.

④ When the rebooted switch comes back up, it assumes the secondary management role within the stack.

Reloading the Secondary Management Module In a Stack of Two

Reloading Switches with Idle Roles

Similar to reloading Network Interface (NI) modules on chassis-based switches, modules operating in idle status within a stack can be reloaded via the CLI.

Note. Any traffic being passed on the module's Ethernet will be interrupted during the reboot. Other modules within the stack will continue to operate without interruption.

To reset a single module operating in idle mode, use the **reload ni** command. Be sure to include the slot number of the idle switch in the command line. For example:

```
-> reload ni 3
```

Only one idle switch can be reloaded at a time. In order to reload multiple idle switches at once, the entire stack must be reloaded using the **reload all** command.

After reloading a switch operating in an idle role, the switch resumes idle status when it comes back up, *despite its saved slot number*. In other words, if an idle switch with a saved slot number of 1 is reloaded, it resumes its previous idle role. Although it has the lowest possible saved slot number, it does not take over the primary management role. In order for this switch to take over the primary role, all switches in the stack must be reloaded.

Note. For more information on reloading all the switches in a stack, refer to [page 7-32](#). For more information on idle status, refer to [page 7-12](#).

Reloading Switches in Pass-Through Mode

Pass-through mode is a state in which a switch has attempted to join a stack but has been denied primary, secondary, and idle status. Because this is essentially an error state, the pass-through condition must be resolved and any modules operating in pass-through mode must be reloaded.

To reload a module operating in pass-through mode, use the **reload pass-through** command. Be sure to include the slot number of the pass-through switch in the command line. For example:

```
-> reload pass-through 1001
```

Note. Before issuing the **reload pass-through** command, be sure to resolve any conditions causing the switch to operate in pass-through mode. Otherwise, the switch is likely to come up again in pass-through mode. For detailed information, including steps used to recover from pass-through, refer to [page 7-13](#).

Reloading All Switches in a Stack

Reloading all switches in the stack is essentially a full reboot of the virtual chassis. This can be useful in restoring a stack's previously configured topology—i.e., the stack's saved slot numbers and management roles. Note, however, that all data flow on the stack is interrupted whenever a full reboot is issued.

To reset all switches in a stack use the **reload all** command. For example:

```
-> reload all
```

Important. Before issuing the **reload all** command, be sure to read the sections below. Understanding topics such as software synchronization and the effects of saved slot information can help users avoid unexpected results following a full stack reboot.

Software Synchronization During a Full Reload

If the checksum value on the stack's non-primary switches differs in any way from the checksum value on the primary switch, the primary switch automatically distributes its system and configuration software to all other switches in the stack whenever a full reload is executed.

During this automatic software synchronization, system and configuration software on the secondary and idle switches is overwritten. Because the primary switch's "last known good" software is propagated to all switches, the synchronization process helps ensure effective redundancy across the stack.

Effects of Saved Slot Number Information on the Reload Process

Depending on the status of saved slot information across the stack, there are different slot numbering and management role scenarios that can occur following a full reboot. For this reason, checking the current stack topology before issuing a full reboot is strongly recommended. To check the current stack topology, use the **show stack topology** command. Refer to the *OmniSwitch CLI Reference Guide* for detailed command information.

Possible saved slot number conditions include:

- All switches have unique saved slot information
- No switches in the stack have saved slot information
- Some switches have saved slot information, others do not
- Two or more switches have duplicate slot information

All Switches Have Unique Saved Slot Information

If a full reload is issued and all switches have unique slot numbers saved to their **boot.slot.cfg** files, the slot numbers will be assigned according to the saved slot information. The primary management role will be given to the switch with the *lowest* saved slot number. The secondary management role will be given to the switch with the *second-lowest* saved slot number. All other switches will be assigned to idle roles.

An illustrated example of this method for assigning slot numbers and management roles is provided on pages [7-23](#) and [7-24](#).

No Switches In the Stack Have Saved Slot Information

If a full reload is issued and no switches in the stack have unique slot numbers, slot numbers will be assigned beginning with the switch with the lowest MAC address. (This can occur if the **boot.slot.cfg** file has been deleted from each switch's /flash directory—e.g., by issuing the **stack clear slot** command for all modules in the stack.)

The switch with the lowest MAC address is assigned slot number 1 and given the primary management role. The switch connected to stacking port A of the primary switch is automatically assigned slot number 2 and given the secondary management role. Stack cabling is then used to determine the dynamic slot numbering of the remaining modules in the stack. The switch immediately adjacent to slot 2 is assigned slot number 3 and given an idle role, etc.

An illustrated example of this method for assigning slot numbers and management roles is provided on pages [7-21](#) and [7-22](#).

Some Switches Have Saved Slot Information, Others Do Not

If only *some* switches in the stack have **boot.slot.cfg** files in their /flash directories, the system software will first read the contents of these files and then dynamically assigns unique slot numbers to any switches that do not have saved slot information. The primary management role will be given to the switch with the *lowest* saved slot number. The secondary management role will be given to the switch with the *second-lowest* saved slot number. All other switches will be assigned to idle roles.

When unique slot numbers are dynamically assigned by the system software, a **boot.slot.cfg** file is automatically generated with the new slot information. Because all switches now have unique saved slot information, any subsequent **reload all** commands issued will cause the stack to come up as described in the section, “[All Switches Have Unique Saved Slot Information](#)” on page [7-32](#).

Two or More Switches Have Duplicate Slot Information

If a full stack reboot is issued and the same slot number is found in the **boot.slot.cfg** file of two or more switches, the switch with the lowest MAC address is allowed to come up and operate normally. Meanwhile, any other switches with the duplicate slot number come up in *pass-through mode*.

The pass-through mode is essentially an error state in which a switch has been denied primary, secondary, and idle roles within the stack. When a switch is in pass-through mode, its Ethernet are brought down and cannot pass traffic. It is for this reason that users should always check the current saved slot number for each switch before issuing the **reload all** command. To check the current saved slot information across the stack, use the **show stack topology** command. For detailed information on pass-through mode, refer to “[Pass-Through Mode](#)” on page [7-13](#).

Avoiding Split Stacks

The term “splitting” a stack refers to the creation of isolated modules within the virtual chassis. A split stack can result from the following conditions:

- Two or more *non-adjacent* switches are reloaded simultaneously
- The stack is reloaded without a redundant stacking cable connection

The sections below offer simple guidelines for avoiding splitting the stack during the reload process.

Do Not Reload Non-Adjacent Switches Simultaneously

If non-adjacent switches in the stack—for example, the top switch in the stack and the third-from-top switch in the stack—are reloaded *simultaneously*, a problem will occur. The switch between the two non-adjacent switches will become isolated and the virtual chassis will be effectively split.

To avoid splitting the stack, do not reload the two non-adjacent switches simultaneously. Instead, simply reload the top switch first, then reload the third-from-top switch, or vice-versa.

Be Sure a Redundant Stacking Cable is Installed at All Times

Another important guideline for avoiding split stacks involves the redundant stacking cable. In order to avoid isolated modules within the virtual chassis, simply make sure that a redundant stacking cable connection exists between the top-most and bottom-most switches at all times.

For more information on the redundant stacking cable connection, refer to [page 7-18](#).

For information on detecting a stack split with Stack Split Protection (SSP), refer to [page 7-38](#).

Changing the Secondary Module to Primary

OmniSwitch 6250 stacks allow users to manually force the secondary switch to assume the primary management role. This is referred to as “takeover.” The behavior of a takeover is similar to that of reloading the primary management module (see [page 7-27](#)).

Whenever a takeover is initiated, the switch with the secondary role automatically takes over primary management functions. The primary switch is automatically reloaded and any traffic being passed on the primary switch’s Ethernet is interrupted.

Meanwhile, the idle switch with the next-lowest slot number automatically assumes the secondary role. When the former primary module comes back up, it assumes an idle role within the stack.

To initiate a takeover sequence, use the **takeover** command. For example:

```
-> takeover
```

Note. Before using the **takeover** command, verify that the switches in the stack are synchronized. Otherwise, data flow and switch management functions may be interrupted due to incorrect or outdated software when a switch takes over the primary management role. For more information, refer to [“Synchronizing Switches in a Stack” on page 7-37](#).

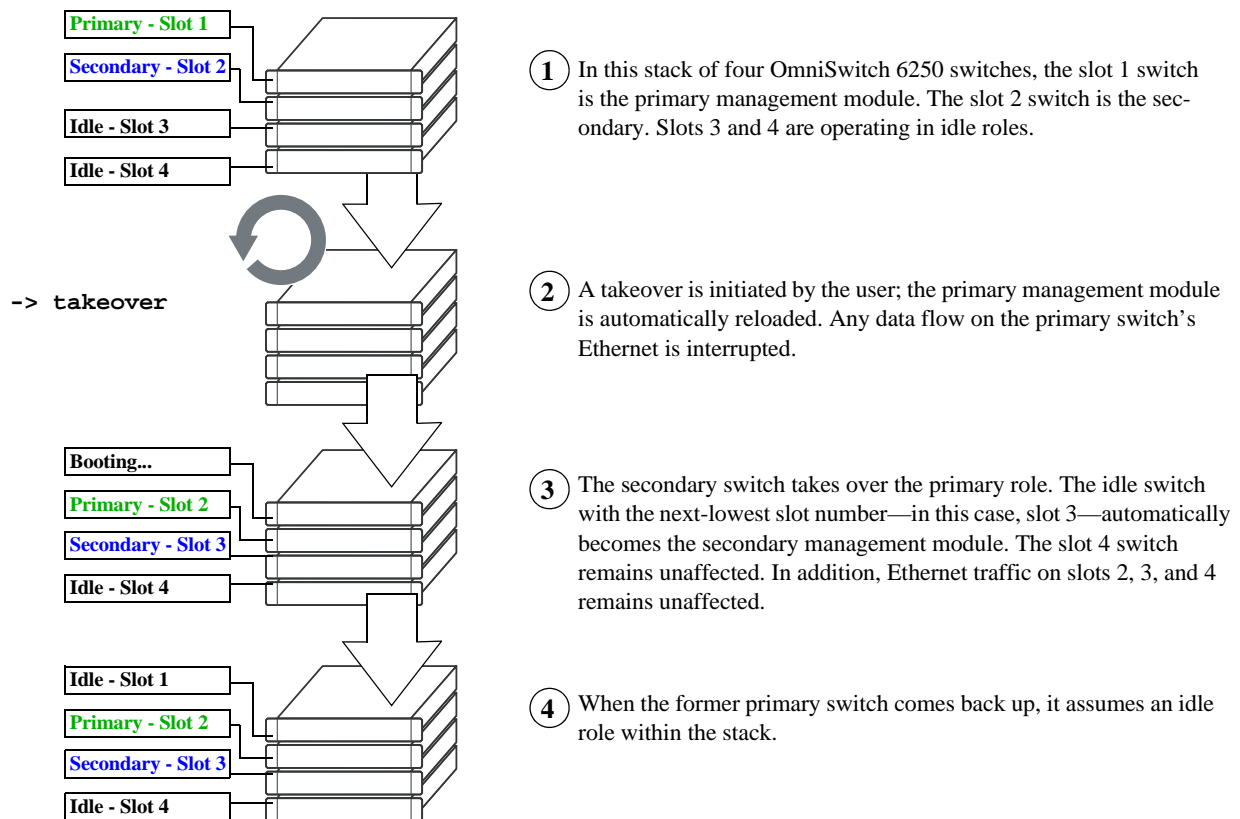

- 1 In this stack of four OmniSwitch 6250 switches, the slot 1 switch is the primary management module. The slot 2 switch is the secondary. Slots 3 and 4 are operating in idle roles.
- 2 A takeover is initiated by the user; the primary management module is automatically reloaded. Any data flow on the primary switch’s Ethernet is interrupted.
- 3 The secondary switch takes over the primary role. The idle switch with the next-lowest slot number—in this case, slot 3—automatically becomes the secondary management module. The slot 4 switch remains unaffected. In addition, Ethernet traffic on slots 2, 3, and 4 remains unaffected.
- 4 When the former primary switch comes back up, it assumes an idle role within the stack.

Takeover Behavior In a Stack of Three or More

If there are only two switches in the stack, the former primary switch resumes the secondary role when it comes back up following the takeover.

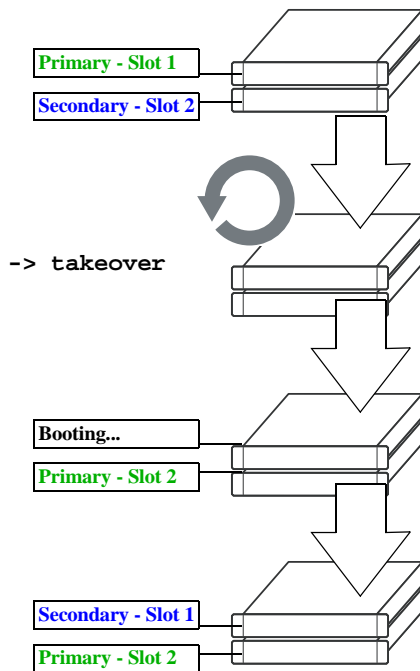

- ① In this stack of two OmniSwitch 6250 switches, the slot 1 switch is the primary management module. The slot 2 switch is the secondary.
- ② A takeover is initiated by the user; the primary management module is automatically reloaded. Any data flow on the primary switch's Ethernet is interrupted.
- ③ The secondary switch takes over the primary role. Ethernet traffic on slot 2 remains unaffected. Meanwhile the stack has no interim secondary management module as the switch reboots.
- ④ When the former primary switch comes back up, it assumes the secondary management role within the stack.

Takeover Behavior In a Stack of Two

Synchronizing Switches in a Stack

Management module synchronization refers to the process of copying all files in the /flash/working and /flash/certified directories of the primary management module to the /flash/working and /flash/certified directories of all the other switches in the stack. The system and configuration software on the non-primary switches—i.e., the secondary management module and any modules operating in idle—is overwritten.

The synchronization process ensures that the contents of these directories match exactly for all switches across the stack. This can be especially useful after new software has been loaded to the primary management module. Further, synchronization prevents any switch from assuming a management role within the stack with incorrect or outdated software or configuration files. Because the primary switch's "last known good" software is propagated to all switches, the synchronization process helps ensure effective redundancy across the stack.

In order to maintain effective management module redundancy, switches in the stack must be synchronized at all times. To determine whether a stack is in need of synchronization, use the [show running-directory](#) command. For example:

```
-> show running-configuration

CONFIGURATION STATUS
  Running CMM           : PRIMARY,
  CMM Mode              : DUAL CMMs,
  Current CMM Slot     : 1,
  Running configuration : WORKING,
  Certify/Restore Status : CERTIFY NEEDED
SYNCHRONIZATION STATUS
  Flash Between CMMs   : NOT SYNCHRONIZED,
  Running Configuration : NOT AVAILABLE,
  Stacks Reload on Takeover: PRIMARY ONLY
```

This example shows a switch on which the /flash directories between the management modules are not synchronized. To manually synchronize all switches in the stack, enter the following command:

```
-> copy working certified flash-syncro
```

When the synchronization process is initiated, modules within the stack continue to operate without interruption and data flow across the stack is unaffected.

Automatic Synchronization During a Full Reload

If the checksum value on the stack's non-primary switches differs in any way from the checksum value on the primary switch, the primary switch automatically distributes its system and configuration software to all other switches in the stack whenever a full reload is executed.

For more information on initiating a full reload, see [“Reloading All Switches in a Stack” on page 7-32](#).

Note. For more information on management module synchronization and managing the /flash/working and /flash/certified directories, refer to the “Managing CMM Directory Content” chapter in the *Switch Management Guide*.

Stack Split Detection (SSP)

In the case of a stack split due to a stacking link failure or the failure of one of the stack elements, both of the resulting stacks could end up having the same system MAC and IP addresses. Since there is no communication between these individual stacks due to the stacking link failure they end up communicating with the rest of the network devices using the same MAC and IP addresses. This stack split scenario is disruptive to the network as the conflicting MAC and IP addresses can lead to layer 2 loops and L3 traffic disruption.

Stack Split Detection provides the following benefits:

- Avoid network disruptions by preventing duplicate MAC and IP addresses on the network when MAC retention is enabled and a stack split occurs.
- The sub-stack that forms out of the stack split is able to detect that a stack split has occurred.
- Once the stack split condition has been determined, the sub-stack will put its front-panel ports into an operationally down state preventing traffic forwarding and avoiding loops and possible traffic disruption. The SSP link will be shut down after the protection mode SSP PDU is sent to the helper and the acknowledgment is received from the helper by the protection mode unit.
- A trap can be sent by the active-stack indicating the stack split state. The trap indicates that the stack split has occurred and which elements are in the operationally down sub-stack.
- A mechanism is available to recover the non-operational sub-stack.
- A method of detecting a stack split in a remote stacking topology where the stack may consist of elements located in different physical locations such as a remote site, or multiple floors of a building.

A redundant stacking cable connection should be used for proper SSP functionality. For more information on helping to avoid stack splits with redundant stacking cable connections, refer to [page 7-18](#).

Stack Split Key Components and Terms

- **SSP PDU** - A proprietary packet forwarded between stack elements to help determine that state of the stack.
- **SSP Helper** - A neighboring OmniSwitch, not an element of the stack, responsible for forwarding SSP PDUs between the stack elements. The SSP feature and the SSP Helper functionality cannot be enabled on the same switch for the same link aggregate ID.
- **SSP Link Aggregate** - A dedicated link aggregate configured between elements of a stack and a helper switch to be used for forwarding SSP PDUs.
- **Active-stack** - An element, or multiple elements, that results when a split stack occurs. The active-stack will keep its front panel ports enabled and continue to forward traffic on the network.
- **Sub-stack** - An element, or multiple elements, that results when a split stack occurs. The sub-stack will disable its front panel ports to prevent traffic disruption caused by duplicate MAC/IP addresses with the active stack.
- **Protection State** - A state an element will transition to after determining a stack split has occurred. Its ports will be operationally disabled to prevent duplicate MAC and IP addresses and network disruption.
- **Guard Timer** - A configurable timer determining how long a unit will wait before beginning to send SSP PDUs after a stack recovery.

Basic Operation

When stack split detection is enabled, a proprietary protocol runs on a configured link aggregate to carry the stack information necessary for stack split detection. Stack elements share a link aggregate with an OmniSwitch that can act as a helper to assist in the stack split detection.

The lowest member port of the link aggregate hosted on the primary element is responsible for sending the SSP PDUs on the member link. When the packet arrives on the remote helper device then the helper device will forward the packet out on all member ports of the link aggregate so that the packet reaches the remote stack elements.

Use the the **stack split-protection** and **stack split-protection linkaggid** commands to enable SSP and create the SSP link aggregate on the stack.

Use the the **stack split-protection helper** and **stack split-protection helper linkagg** commands to enable the SSP helper and create the SSP helper link aggregate on the helper switch.

Protection States

Under normal stack circumstances the SSP PDUs are sent once every 3 seconds. When the stack detects a scenario which leads to a change in its size the protocol sends the SSP PDUs at a rate of 1 per 250 milliseconds for 120 seconds. This helps to quickly identify a stack split.

On reception of a SSP frame, the receiving elements match the primary of their current stack against the MAC address of the SSP sender. If there is a mismatch between the two, then that indicates the presence of an active stack in the network which is disconnected from the current stack. In this condition the stack element will monitor 3-5 such consecutive frames, after which it will transition to the **protection state**.

When an element transitions to the protection state, the following occurs:

- Each of the stack elements will independently transition into the protection state.
- In the protection state each of the stack elements will disable all the user ports except the ones belonging to the SSP protection link aggregate.
- The stack element will store the protection state transition information in a non-volatile location (EEPROM/ boot.params). This information will be used whenever an element in the protection state re-boots and needs to check its current operational state.
- An element in the protection state will send an SSP PDU back on the link aggregate carrying the SSP state as PROTECTION. This is the only frame that is sent by the protection sub-stack. The purpose of this message is to inform the active-stack to generate an SNMP trap regarding the stack split state of the stack element.

Stack Split Recovery

Once a sub-stack goes into the protection state then all the front panel ports are put into an operationally down state. There are two ways to recover the stack, manually or automatically.

Manual Recovery

If the guard timer is 0, automatic recovery is disabled and the sub-stack stays in protection mode until the unit is reloaded by the administrator. After the re-boot the administrator has to manually recover the switch by first disabling SSP and then re-enabling SSP. This clears the protection state variables stored in the EEPROM/boot.params.

Use the **stack split-protection guard-timer** and the **stack split-protection** commands to configure the guard timer and enable/disable SSP.

Automatic Recovery

If the stacking link recovers and the sub-stack reconnects to the active stack the sub-stack will automatically reboot. The protection units will come up in the protection state; however they will now be part of the active stack but their front panel ports will still be disabled. The primary of the combined stack will detect that there are new elements in the protection state. The primary will wait for the guard timer to expire and will then bring one element at a time from the protection state until all elements are active.

Once complete, the primary will generate a trap indicating the stack has been recovered.

1 Normal Operation

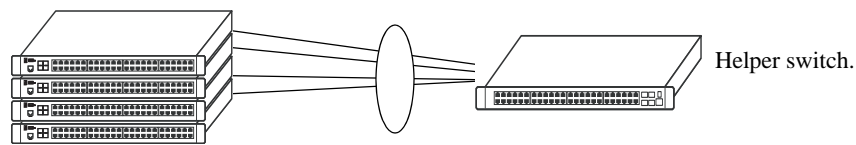

SSP PDUs sent over helper linkagg and relayed by helper switch.

2 Stack Split

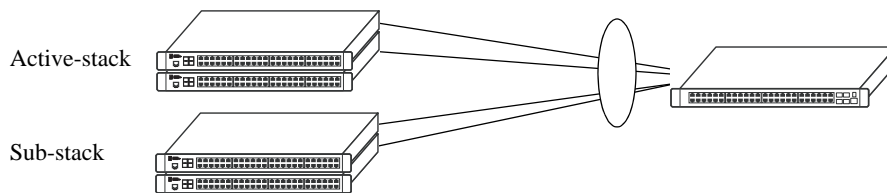

1. Stack split detected, substack transitions to PROTECTION state.
2. Sub-stack front panel ports shutdown to avoid duplicate addresses on network
3. PROTECTION PDUs sent by sub-stack to active-stack over helper linkagg.
4. Active-stack sends trap indicating stack split.

3 Recovery

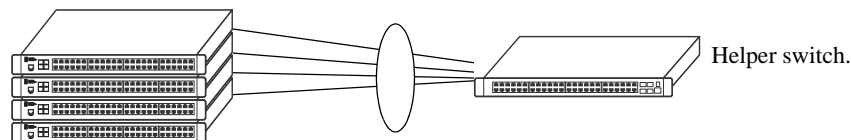

1. Stacking link recovers, new elements detected by Primary.
2. Manual Recovery - Administrator disables/enables SSP to clear PROTECTION state.
3. Automatic Recovery - After guard-timer expiration, Primary will bring up elements one at a time.
4. Once stack is functioning, Primary will send trap indicating stack recovery.

Stack Split Example

Monitoring the Stack

As shown in the previous sections, monitoring the current status and operation of all elements in a stack can help users avoid unexpected stack conditions. The table below includes CLI commands that are useful in monitoring stack conditions.

CLI Commands Used for Monitoring a Stack	
show stack topology	Displays the current operating topology of switches within a stack.
show stack status	Displays the current redundant stacking cable status.
show running-directory	Displays the directory from where the switch was booted. This command also shows important information, including whether the software across the stack is synchronized.
show chassis	Displays basic configuration and status information for the switch chassis.
show cmm	Displays basic hardware and status information for primary and secondary management modules operating in the stack.
show ni	Displays basic hardware and status information for modules currently operating in the stack.
show module	Displays basic information for modules installed in the stack. Modules include primary and secondary management modules and any modules operating in idle status.
show module long	Displays detailed information for modules installed in the stack. Modules include primary and secondary management modules and any modules operating in idle status.
show module status	Displays basic status information for modules installed in the stack. Modules include primary and secondary management modules and any modules operating in idle status.
show power	Displays hardware information and current status for chassis power supplies. This includes the status of backup power supplies, if applicable.
show fan	Displays the current operating status of each of the six fans operating in each chassis.
show temperature	Displays the current operating chassis ambient temperature, as well as current temperature threshold settings for each of the modules in the stack.
show stack split-protection status	This command displays all the information related to SSP when enabled.
show stack split-protection statistics	This command shows statistics of stack split-protection.
show stack split-protection stacking-units	This command shows the SSP state of all stacked units.

Visually Monitoring the Stack

Users can also monitor many stack operations by viewing the front panel LEDs on all elements in the stack. Refer to [“LED Status” on page 3-20](#) for detailed information on LEDs and stack status.

A Regulatory Compliance and Safety Information

This appendix provides information on regulatory agency compliance and safety for OmniSwitch 6250 switches.

Declaration of Conformity: CE Mark

This equipment is in compliance with the essential requirements and other provisions of Directive 2004/108/EC (EMC), 2006/95/EC (LVD), 91/263/EEC (Telecom Terminal Equipment, if applicable), 1999/5/EC (R&TTE, if applicable).

Français: Cet équipement est conforme aux exigences essentielles et aux autres provisions de la Directive 2004/108/EC (EMC), 2006/95/CE (LVD), 91/263/CEE (équipements terminaux de télécommunications, le cas échéant), 1999/5/EC (R&TTE, le cas échéant).

Deutsch: Diese Ausrüstung erfüllt die wesentlichen Anforderungen und sonstigen Bestimmungen der Richtlinien 2004/108/EG (EMV-Richtlinie), 2006/95/EG (Niederspannungsrichtlinie), 91/263/EWG (Telekommunikationsendeinrichtungen, falls zutreffend), 1999/5/EG (Funkanlagen und Telekommunikationsendeinrichtungen, falls zutreffend).

Español: Este equipo cumple los requisitos esenciales y otras disposiciones de las directivas 2004/108/CE (EMC), 2006/95/CE (LVD), 91/263/CEE (equipos terminales de telecomunicación, si procede), 1999/5/CE (R&TTE, si procede).

China RoHS: Hazardous Substance Table

产品说明书附件

SUPPLEMENT TO PRODUCT INSTRUCTIONS

这个文件涉及的是在中华人民共和国境内进口或销售的电子信息产品
Include this document with all Electronic Information Products imported or sold in the People's Republic of China

部件名称 (Parts)	有毒有害物质或元素 (Hazardous Substance)					
	铅 (Pb)	汞 (Hg)	镉 (Cd)	六价铬 (Cr ⁶⁺)	多溴联苯 (PBB)	多溴二苯醚 (PBDE)
电路模块 (Circuit Modules)	×	○	○	○	○	○
电缆及电缆组件 (Cables & Cable Assemblies)	×	○	○	○	○	○
金属部件 (Metal Parts)	×	○	○	○	○	○
塑料和聚合物部件 (Plastic and Polymeric parts)	○	○	○	○	○	○
对于交付时集成了电池的电子信息产品 For electronic information products delivered with integrated functional batteries:						
电池 (Batteries)	○	○	○	○	○	○
<p>○：表示该有毒有害物质在该部件所有均质材料中的含量均在 SJ/T11363-2006 标准规定的限量要求以下。 Indicates that the concentration of the hazardous substance in all homogeneous materials in the parts is below the relevant threshold of the SJ/T11363-2006 standard.</p> <p>×：表示该有毒有害物质至少在该部件的某一均质材料中的含量超出SJ/T11363-2006标准规定的限量要求。 Indicates that the concentration of the hazardous substance of at least one of all homogeneous materials in the parts is above the relevant threshold of the SJ/T11363-2006 standard.</p> <p>对销售之日的所售产品, 本表显示, 阿尔卡特朗讯公司供应链的电子信息产品可能包含这些物质。注意: 在所售产品中可能会也可能不会含有所有所列的部件。 This table shows where these substances may be found in the supply chain of Alcatel-Lucent electronic information products, as of the date of sale of the enclosed product. Note that some of the component types listed above may or may not be a part of the enclosed product.</p>						

除非另外特别的标注, 此标志为针对所涉及产品的环保使用期标志。某些零部件会有一个不同的环保使用期(例如, 电池单元模块)贴在其产品上。

此环保使用期限只适用于产品是在产品手册中所规定的条件下工作。

The Environment-Friendly Use Period (EFUP) for all enclosed products and their parts are per the symbol shown here, unless otherwise marked. Certain parts may have a different EFUP (for example, battery modules) and so are marked to reflect such. The Environment-Friendly Use Period is valid only when the product is operated under the conditions defined in the product manual.



Products are packaged using one or more of the following packaging materials:

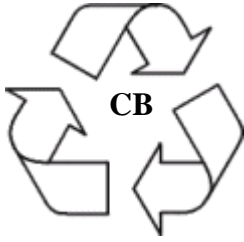

Corrugated Cardboard

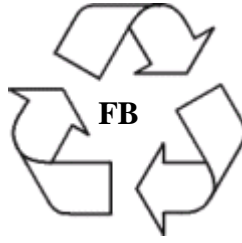

Corrugated Fiberboard



LDPE

Low-Density Polyethylene

California Proposition 65 Warning

WARNING: This product contains chemicals known to the State of California to cause cancer and birth defects or other reproductive harm.

Waste Electrical and Electronic Equipment (WEEE) Statement

The product at end of life is subject to separate collection and treatment in the EU Member States, Norway and Switzerland and therefore marked with the symbol:

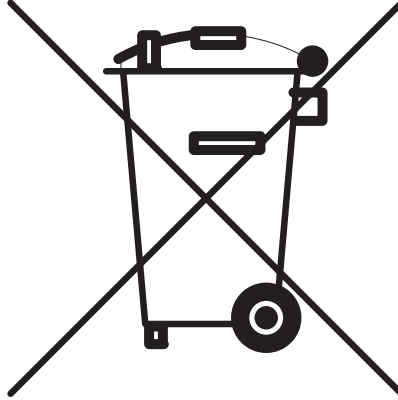

Treatment applied at end of life of the product in these countries shall comply with the applicable national laws implementing directive 2002/96EC on waste electrical and electronic equipment (WEEE).

Standards Compliance

Safety Agency Certifications

- UL 60950-1, 2nd Edition
- CAN/CSA-C22.2 No. 60950-1-07, 2nd Edition
- EN 60950-1 with Amendment II
- IEC 60950-1 2nd Edition
- AS/NZS TS-001 and 60950: Australia
- UL-AR, Argentina
- TUV,UL-GS Mark, Germany
- NOM-019 SCFI, Mexico
- EN 60825-1 Laser
- EN 60825-2 Laser
- CDRH Laser
- CB Certification per IEC 60950-1, Second Edition

EMI/EMC Standards

- FCC Part 15 (CFR 47) Class A
- ICES-003 Class A
- EN 55022: Class A
- CISPR 22 Class A
- AS/NZS 3548 Class A
- VCCI Class A; A1 and A2
- EN 55024 (Immunity)
- EN 61000-3-2
- EN 61000-3-3
- EN 61000-4-2
- EN 61000-4-3
- EN 61000-4-4
- EN 61000-4-5
- EN 61000-4-6
- EN 61000-4-8
- EN 61000-4-11
- EN 61000-6-2
- EN 61000-6-4

FCC Class A, Part 15

This equipment has been tested and found to comply with the limits for Class A digital device pursuant to Part 15 of the FCC Rules. These limits are designed to provide reasonable protection against harmful interference when the equipment is operated in a commercial environment. This equipment generates, uses, and can radiate radio frequency energy and, if not installed and used in accordance with the instructions in this guide, may cause interference to radio communications. Operation of this equipment in a residential area is likely to cause interference, in which case the user will be required to correct the interference at his own expense.

The user is cautioned that changes and modifications made to the equipment without approval of the manufacturer could void the user's authority to operate this equipment. It is suggested that the user use only shielded and grounded cables to ensure compliance with FCC Rules.

If this equipment does cause interference to radio or television reception, the user is encouraged to try to correct the interference by one or more of the following measures:

- Reorient the receiving antenna.
- Relocate the equipment with respect to the receiver.
- Move the equipment away from the receiver.
- Plug the equipment into a different outlet so that equipment and receiver are on different branch circuits.

If necessary, the user should consult the dealer or an experienced radio/television technician for additional suggestions.

Canada Class A Statement

This equipment does not exceed Class A limits per radio noise emissions for digital apparatus, set out in the Radio Interference Regulation of the Canadian Department of Communications.

Avis de conformité aux normes du ministère des Communications du Canada

Cet équipement ne dépasse pas les limites de Classe A d'émission de bruits radioélectriques pour les appareils numériques, telles que prescrites par le Règlement sur le brouillage radioélectrique établi par le ministère des Communications du Canada.

JATE

This equipment meets the requirements of the Japan Approvals Institute of Telecommunications Equipment (JATE).

CISPR22 Class A warning

This is a Class A product. In a domestic environment, this product may cause radio interference. Under such circumstances, the user may be requested to take appropriate countermeasures.

Korean Emission Statement

A 급 기기 (업무용 방송통신 기자재)

이 기기는 업무용 (A 급) 전자파적합기기로서 판매자 또는 사용자는 이 점을 주의하시기 바라며, 가정외의 지역에서 사용하는 것을 목적으로 합니다.

Class A Equipment (Business equipment)

This equipment is registered for Electromagnetic Conformity Registration as business equipment (A), not home equipment. Sellers or users are required to take caution in this regard.

VCCI

This is a Class A product based on the standard of the Voluntary Control Council for Interference by Information Technology Equipment (VCCI). If this equipment is used in a domestic environment, radio disturbance may arise. When such trouble occurs, the user may be required to take corrective actions.

この装置は、情報処理装置等電波障害自主規制協議会（VCCI）の基準に基づくクラス A 情報技術装置です。この装置を家庭環境で使用すると電波妨害を引き起こすことがあります。この場合には使用者が適切な対策を講ずるよう要求されることがあります。

Class A Warning for Taiwan and Other Chinese Markets

This is a Class A Information Product. When used in a residential environment, it may cause radio frequency interference. Under such circumstances, the user may be requested to take appropriate counter-measure.

警告使用者：

這是甲類的資訊產品，在居住的環境中使用時，可能會造成射頻干擾，在這種情況下，使用者會被要求採取某些適當的對策。

Network Cable Installation Warning

Never install exposed network cables outdoors. Install network cables per manufacturer requirements.

Translated Safety Warnings

Chassis Lifting Warning

Two people are required when lifting the chassis. Due to its weight, lifting the chassis unassisted can cause personal injury. Also be sure to bend your knees and keep your back straight when assisting with the lifting of the chassis.

Français: Le châssis doit être soulevé par deux personnes au minimum. Pour éviter tout risque d'accident, maintenez le dos droit et poussez sur vos jambes. Ne soulevez pas l'unité avec votre dos.

Deutsch: Sicherheitshinweise

Hinweise zur Anhebung des Chassis

Zum Anheben des Chassis werden zwei Personen benötigt. Aufgrund des Gewichts kann das Anheben ohne Unterstützung zu Personenschäden führen. Heben Sie das Chassis aus den Knien und halten Sie den Rücken gerade wenn Sie beim Anheben des Chassis assistieren.

Español: Se requieren dos personas para elevar el chasis. Para evitar lesiones, mantenga su espalda en posición recta y levante con sus piernas, no con su espalda.

Electrical Storm Warning

To avoid a shock hazard, do not connect or disconnect any cables or perform installation, maintenance, or reconfiguration of this product during an electrical storm.

Français: Ne pas travailler sur le système ni brancher ou débrancher les câbles pendant un orage.

Deutsch: Hinweise bei Unwetter

Um elektrische Schläge zu vermeiden dürfen während eines Gewitters and diesem Gerät keine Kabel angeschlossen oder gelöst werden, sowie keinerlei Installationen, Wartungen oder Konfigurationen vorgenommen werden.

Español: Para evitar peligro de descargas, no conecte o desconecte ningún cable, ni realice ninguna instalación, mantenimiento o reconfiguración de este producto durante una tormenta eléctrica.

Installation Warning

Only personnel knowledgeable in basic electrical and mechanical procedures should install or maintain this equipment.

Français: Toute installation ou remplacement de l'appareil doit être réalisée par du personnel qualifié et compétent.

Deutsch: Installationshinweise

Dieses Gerät soll nur von Personal installiert oder gewartet werden, welches in elektrischen und mechanischen Grundlagen ausgebildet ist.

Español: Estos equipos deben ser instalados y atendidos exclusivamente por personal adecuadamente formado y capacitado en técnicas eléctricas y mecánicas.

Invisible Laser Radiation Warning

Lasers emit invisible radiation from the aperture opening when no fiber-optic cable is connected. When removing cables do not stare into the open apertures. In addition, install protective aperture covers to fiber with no cable connected.

Français: Des radiations invisibles à l'œil nu pouvant traverser l'ouverture du port lorsque aucun câble en fibre optique n'y est connecté, il est recommandé de ne pas regarder fixement l'intérieur de ces ouvertures. Installez les caches connecteurs prévus à cet effet.

Deutsch: Hinweise zur unsichtbaren Laserstrahlung

Die Laser strahlen an der Blendenöffnung unsichtbares Licht ab, wenn keine Glasfaserkabel angeschlossen sind. Blicken Sie nicht in die Öffnungen und installieren Sie unverzüglich die Abdeckungen über den Glasfaseranschlüssen.

Español: Debido a que la apertura del puerto puede emitir radiación invisible cuando no hay un cable de fibra conectado, procurar no mirar directamente a las aperturas para no exponerse a la radiación.

Power Disconnection Warning

Your switch is equipped with multiple power supplies. To reduce the risk of electrical shock, be sure to disconnect all power connections before servicing or moving the unit.

Français: Il se peut que cette unité soit équipée de plusieurs raccordements d'alimentation. Pour supprimer tout courant électrique de l'unité, tous les cordons d'alimentation doivent être débranchés.

Deutsch: Hinweise zur Spannungsfreischaltung

Ihr Gerät ist mit mehreren Netzteilen ausgerüstet. Um die Gefahr des elektrischen Schlages zu verringern, stellen sie sicher, daß alle Netzverbindungen getrennt sind bevor das Gerät gewartet oder bewegt wird.

Español: Antes de empezar a trabajar con un sistema, asegúrese que el interruptor está cerrado y el cable eléctrico desconectado.

Proper Earthing Requirement Warning

To avoid shock hazard:

- The power cord must be connected to a properly wired and earth receptacle.
- Any equipment to which this product will attached must also be connected to properly wired receptacles.
- Use 22AWG solid copper conductor for ground leads connecting the frame to ground and DC return.
- Cleaning and dressing of grounding points during installation is strongly recommended. Also, do not forget the antioxidant.
- To ground the equipment properly, connect a Panduit Corporation UL listed Lug, P/N: LCD8-10A-L to the two threaded holes located on the rear using 8AWG copper conductors. Use Panduit Corporation, P/N: CT-940CH for crimping.

Français:

Pour éviter tout risque de choc électrique:

- Ne jamais rendre inopérant le conducteur de masse ni utiliser l'équipement sans un conducteur de masse adéquatement installé.
- En cas de doute sur la mise à la masse appropriée disponible, s'adresser à l'organisme responsable de la sécurité électrique ou à un électricien.

Deutsch: Hinweise zur geforderten Erdung des Gerätes

Aus Sicherheitsgründen:

- darf das Netzkabel nur an eine Schutzkontaktsteckdose angeschlossen werden.
- dürfen für den Anschluß anderer Geräte, welche mit diesem Gerät verbunden sind, auch nur Schutzkontaktsteckdosen verwendet werden.

Español:

Para evitar peligro de descargas:

- Para evitar peligro de descargas asegurese de que el cable de alimentación está conectado a una toma de alimentación adecuadamente cableada y con toma de tierra.
- Cualquier otro equipo a cual se conecte este producto también debe estar conectado a tomas de alimentación adecuadamente cableadas.

Read Important Safety Information Warning

This guide contains important safety information about which you should be aware when working with hardware components in this system. You should read this guide before installing, using, or servicing this equipment.

Français: Avant de brancher le système sur la source d'alimentation, consultez les directives d'installation disponibles dans ceci guide.

Deutsch: Bitte lesen - Sicherheitshinweise

Dieses guide enthält wichtige Sicherheitsinformationen, über die sie sich beim Arbeiten mit den Hardwareeinheiten bewußt sein sollten. Sie sollten diese Hinweise lesen, bevor sie installieren, reparieren oder die Anlage verwenden.

Español: Esto guide contiene información importante de seguridad sobre la cual usted debe estar enterado al trabajar con los componentes de dotación física en este sistema. Usted debe leer esta guía antes de instalar, usar o mantener este equipo.

Restricted Access Location Warning

This equipment should be installed in a location that restricts access. A restricted access location is one where access is secure and limited to service personnel who have a special key, or other means of security.

Français: Le matériel doit être installé dans un local avec accès limité ou seules les personnes habilitées peuvent entrer.

Deutsch: Hinweis zu Umgebungen mit beschränktem Zutritt

Die Anlage sollte an einem Standort mit beschränktem Zutritt installiert sein. Ein Standort mit beschränktem Zutritt stellt sicher, daß dort nur Servicepersonal mit Hilfe eines Schlüssels oder eines anderen Sicherheitssystems Zugang hat.

Español: Este equipo se debe instalar en un sitio con acceso restringido. Un sitio con el acceso restringido es uno seguro y con acceso limitado al personal de servicio que tiene una clave especial u otros medios de seguridad.

Wrist Strap Warning

Because electrostatic discharge (ESD) can damage switch components, you must ground yourself properly before continuing with the hardware installation. For this purpose, Alcatel-Lucent provides a grounding wrist strap and a grounding lug located near the top-right of the chassis. For the grounding wrist strap to be effective in eliminating ESD, the power supplies must be installed in the chassis and plugged into grounded AC outlets.

Français: L'électricité statique (ESD) peut endommager les composants du commutateur. Pour cette raison Alcatel-Lucent joint à l'envoi du châssis un bracelet antistatique à brancher sur la prise mise à la terre située en bas à droite du commutateur. Vous devrez mettre ce bracelet avant toute intervention hardware.

Deutsch: Hinweise zur ESD (Elektrostatischen Aufladung)

Weil elektrostatische Aufladung (ESD) Teile der Anlage beschädigen könnten, müssen sie sich selbst erden, bevor sie mit der Hardware Installation beginnen. Zu diesem Zweck stellt Alcatel-Lucent ein Erdungsarmband und eine Erdungsöse an der oberen rechten Seite des Chassis zur Verfügung. Um eine sichere Erdungsfunktion des Erdungsarmbandes sicherzustellen, müssen die Netzteile installiert und mit dem Schutzleiter des Versorgungsstromkreises verbunden sein.

Español: La descarga electrostática (ESD) puede dañar componentes electrónicos. Usted debe asegurarse que está en contacto con tierra antes de hacer la instalación del equipo. Con este fin, Alcatel-Lucent proporciona una pulsera de muñeca para conectar al chasis en la toma de tierra situada en la parte superior derecha del chasis. Para que la correa de muñeca sea eficaz en la eliminación de ESD, las fuentes de alimentación deben estar instaladas en el chasis y conectadas a enchufes CA con tierra adecuada.

Instrucciones de seguridad en español

Advertencia sobre el levantamiento del chasis

Se requieren dos personas para levantar el chasis. Debido a su peso, la elevación del chasis sin ayuda puede causar daños corporales. También es seguro doblar sus rodillas y guardar su espalda derecho al ayudar a levantar el chasis.

Advertencia de las tapaderas en blanco

Porque regulan la circulación de aire y ayudan a proteger componentes internos del chasis, las tapaderas en blanco deben seguir instaladas en las ranuras vacías del módulo y la fuente de alimentación siempre.

Advertencia en caso de tormenta eléctrica

Para evitar peligro de descargas, no conecte o desconecte ningún cable, ni realice ninguna instalación, mantenimiento o reconfiguración de este producto durante una tormenta eléctrica.

Advertencia de instalación

Solamente el personal bien informado en procedimientos eléctricos y mecánicos básicos debe instalar o mantener este equipo.

Advertencia de radiación láser invisible

Los lasers emiten radiación invisible de la apertura abierta cuando no se conecta ningún cable de fibra óptica. Al quitar los cables no mire fijamente en las aberturas abiertas. Además, instale las cubiertas protectoras de la apertura a las salidas de la fibra sin el cable conectado.

Advertencia de la batería de litio

Hay un peligro de la explosión si la batería del litio en su chasis se substituye incorrectamente. Substituya la batería solamente por el mismo o el equivalente de tipo de batería recomendado por el fabricante. Deseche las baterías usadas según las instrucciones del fabricante. Las instrucciones del fabricante son como sigue: Devuelva el módulo con la batería del litio a Alcatel-Lucent. La batería del litio será substituida en la fábrica de Alcatel-Lucent.

Advertencia sobre la tensión de operación

Para reducir el riesgo del choque eléctrico, mantenga sus manos y dedos fuera de la fuente de alimentación y no toque la placa madre mientras que el interruptor está funcionando.

Advertencia sobre la desconexión de la fuente

Su interruptor esta equipado por fuentes de alimentación múltiples. Para reducir el riesgo de choque eléctrico, asegúrese desconectar todas las conexiones de alimentación antes de mantener o de mover la unidad.

Advertencia sobre una apropiada conexión a tierra

Para evitar peligro de descargas:

- El cable de alimentación debe estar conectado a una toma de alimentación adecuadamente cableada y con toma de tierra.

Cualquier equipo al cual se conecte este producto debe estar también conectado a tomas de alimentación adecuadamente cableadas.

Leer “información importante de seguridad”

La *Guía de “Comenzando a Usar”* que acompaña este equipo contiene información importante de seguridad sobre la cual usted debe saber al trabajar con los componentes de dotación física en este sistema. Usted debe leer esta guía antes de instalar, de usar, o de mantener este equipo.

Advertencia de acceso restringido

Este equipo se debe instalar en una ubicación que restrinja el acceso. Una ubicación con acceso restringido es una donde está seguro y limitado el acceso al personal de servicio que tiene un clave especial, u otros medios de la seguridad.

Advertencia de pulsera antiestática

Debido a que la descarga electrostática (ESD) puede dañar componentes del interruptor, usted debe conectarse a tierra correctamente antes de continuar con la instalación del equipo. Para este propósito, Alcatel-Lucent proporciona una pulsera antiestática y un terminal que pone a tierra situados cerca de la parte superior derecha del chasis. Para que la pulsera antiestática sea eficaz en la eliminación de ESD, las fuentes de alimentación se deben instalar en el chasis y enchufar en las salidas de CA con descarga a tierra.

Clase de seguridad

Cumple con 21CFR 1040.10 y 1040.11 ó sus equivalentes.